

2023



RUBBER
HOLLAND



30
jaar

1993 - 2023



BATTERY CABLE

BATTERIE KABEL

ACCUKABELS

ELECTRICITY

STROM

ELECTRA

PVC AND RUBBER PRODUCTS

PVC- UND GUMMIPRODUKTE

PVC- EN RUBBERPRODUCTEN

HOSES

SCHLAUCHEN

SLANGEN

HOSE CLAMPS

SCHLAUCHSCHELLEN

KLEMMEN

FITTINGS

FITTINGS

FITWERK

HEP20

HEP20

HEP20 SYSTEEM

LOOPVLAKSTRUCTUREN

TERMS AND CONDITIONS

ALGEMENE (LEVERINGS)VOORWAARDEN



ACCUKABELS
BATTERY CABLES
BATTERIE KABEL

FLEXIBELE ACCUKABEL

- OLIBESTENDIG - OIL RESISTANT - ÖLBESTÄNDIG
- ZEER FLEXIBEL - CLASS 6 VERY FLEXIBLE - KLASSE 6 KABEL

 VOOR DATASHEET KIJK OP ONZE WEBSITE
 LOOK FOR DATASHEET ON OUR WEBSITE
 FÜR DATASHEET SCHAU UNSERE WEBSITE



DUBBELGEÏSOLEERDE ACCUKABEL ROOD DOUBLE ISOLATED BATTERYCABLE RED DOPPEL ISOLIERTE BATTERIEKABEL ROT

DUBBELGEÏSOLEERDE ACCUKABEL ZWART DOUBLE ISOLATED BATTERYCABLE BLACK DOPPEL ISOLIERTE BATTERIEKABEL SCHWARZ

nr.	mm ²	reel / rolle / haspel
3399910/r	10	50
3399916/r	16	50
3399925/r	25	50
3399935/r	35	50
3399950/r	50	50
3399970/r	70	50
3399995/r	95	50
3399120/r	120	50
drum		
3399910/r500	10	500
3399916/r500	16	500
3399925/r500	25	500
3399935/r500	35	500
3399950/r500	50	500
3399970/r500	70	500
3399995/r500	95	500
3399120/r500	120	500

nr.	mm ²	reel / rolle / haspel
3399910/z	10	50
3399916/z	16	50
3399925/z	25	50
3399935/z	35	50
3399950/z	50	50
3399970/z	70	50
3399995/z	95	50
3399120/z	120	50
drum		
3399910/z500	10	500
3399916/z500	16	500
3399925/z500	25	500
3399935/z500	35	500
3399950/z500	50	500
3399970/z500	70	500
3399995/z500	95	500
3399120/z500	120	500

DUBBELGEÏSOLEERDE ACCUKABEL ORANJE DOUBLE ISOLATED BATTERYCABLE ORANGE DOPPEL ISOLIERTE BATTERIEKABEL ORANGE

nr.	mm ²	reel / rolle / haspel
3399916/o	16	50
3399925/o	25	50
3399935/o	35	50
3399950/o	50	50
3399970/o	70	50
3399995/o	95	50

Op aanvraag leverbaar / on request / auf anfrag: 500 meter



DUBBELGEÏSOLEERDE ACCUKABEL DOUBLE ISOLATED BATTERYCABLE DOPPEL ISOLIERTE BATTERIEKABEL IEC 60332-3

nr.		mm ²	reel / rolle / haspel
9530016/r	●	16	50
9530016/z	●	16	50
9530025/r	●	25	50
9530025/z	●	25	50
9530035/r	●	35	50
9530035/z	●	35	50
9530050/r	●	50	50
9530050/z	●	50	50
9530070/r	●	70	50
9530070/z	●	70	50
9530095/r	●	95	50
9530095/z	●	95	50

 Indien kabels gebundeld of door een bedradingskoker gelegd worden dienen kabels aan de strengere eis van de IEC 60332-3 te voldoen.

 When cables are bundled or put trough a cable tray the cable has to perform according to the requirments of the IEC 60332-3.

 Wen Kabel gebundelt oder durch einen Kabelstreifen gefurht werden, müssen die Kabel den strengen Anfirderungen der IEC 60332-3 entsprechen.



KABELSNIJDER CABLE CUTTER KABELSCHNEIDER

nr.	
3459090	SFK 45 Elec



HALOGEENVRIJE VERTINDE KABELS HALOGEN FREE TINNED CABLE HALOGENFREIES VERZINNTES KABEL

90 °C LLOYDS

nr.		mm ²	reel / rolle / haspel
3377716/r	●	16	50
3377716/z	●	16	50
3377725/r	●	25	50
3377725/z	●	25	50
3377735/r	●	35	50
3377735/z	●	35	50
3377750/r	●	50	50
3377750/z	●	50	50
3377770/r	●	70	50
3377770/z	●	70	50
3377795/r	●	95	50
3377795/z	●	95	50



KABELSCHOENEN POWERLUGS KABELSCHUHE

BLADZIJDE / PAGE / ZEITE 24- 26

 **DUNWANDIGE LAAG SPANNINGS BEDRADINGSKABEL**
THINWALL CABLE: ONLY DC
EINADRIGE ANSCHLUSS UND STEUR KABEL NUR DC

- ISO 6722-1:2011 (CLASS B) 105° C
- 12V / 24V SYSTEMEN (MAX 60V)
- -40° C TOT 105°C
- OLIEBESTENDIG - OIL RESISTANT - ÖLBESTÄNDIG



nr.	mm ²		reel / rolle / haspel
340501/100	0,5	●	100
340502/100	0,5	●	100
340507/100	0,5	●	100
340505/100	0,5	●	100
340506/100	0,5	●	100
340503/100	0,5	●	100
340508/100	0,5	●	100
340509/100	0,5	●	100
340510/100	0,5	●	100
340511/100	0,5	○	100
340512/100	0,5	●	100
340504/100	0,5	●	100

340751/100	0,75	●	100
340752/100	0,75	●	100
340757/100	0,75	●	100
340755/100	0,75	●	100
340756/100	0,75	●	100
340753/100	0,75	●	100
340758/100	0,75	●	100
340759/100	0,75	●	100
3407510/100	0,75	●	100
3407511/100	0,75	○	100
3407512/100	0,75	●	100
340754/100	0,75	●	100

341001/100	1	●	100
341002/100	1	●	100
341007/100	1	●	100
341005/100	1	●	100
341006/100	1	●	100
341003/100	1	●	100
341008/100	1	●	100
341009/100	1	●	100
341010/100	1	●	100
341011/100	1	○	100
341012/100	1	●	100
341004/100	1	●	100

nr.	mm ²		reel / rolle / haspel
341501/100	1,5	●	100
341502/100	1,5	●	100
341507/100	1,5	●	100
341505/100	1,5	●	100
341506/100	1,5	●	100
341503/100	1,5	●	100
341508/100	1,5	●	100
341509/100	1,5	●	100
341510/100	1,5	●	100
341511/100	1,5	○	100
341512/100	1,5	●	100
341504/100	1,5	●	100

342001/100	2	●	100
342002/100	2	●	100
342006/100	2	●	100
342004/100	2	●	100
342005/100	2	●	100
342003/100	2	●	100
342007/100	2	●	100
342008/100	2	●	100
342009/100	2	●	100
342010/100	2	○	100
342011/100	2	●	100

342501/100	2,5	●	100
342502/100	2,5	●	100
342511/100	2,5	●	100
342503/100	2,5	●	100
342504/100	2,5	●	100
342505/100	2,5	●	100
342506/100	2,5	●	100
342507/100	2,5	○	100
342508/100	2,5	●	100

3440001/100	4	●	100
3440002/100	4	●	100
3440003/100	4	●	100
3440004/100	4	●	100

346001/100	6	●	100
346003/100	6	●	100
346004/100	6	●	100
346002/100	6	●	100
346005/100	6	●	100

349001/100	10	●	100
349003/100	10	●	100
349002/100	10	●	100



 **DUNWANDIGE LAAG SPANNINGS BEDRADINGSKABEL**
THINWALL CABLE: ONLY DC
EINADRIGE ANSCHLUSS UND STEUR KABEL NUR DC

- TWEEKLEURIGE KABEL / TWOCOLORED CABLE / ZWEIFARBIGE KABEL
- ISO 6722-1:2011 (CLASS B) 105° C
- 12V / 24V SYSTEMEN (MAX 60V)
- -40° C > 105°C
- OLIEBESTENDIG - OIL RESISTANT - ÖLBESTÄNDIG



nr.	mm ²		reel / rolle / haspel
340513/100	0,5	● —	100
340514/100	0,5	● —	100
340515/100	0,5	● —	100
340516/100	0,5	● —	100
340517/100	0,5	● —	100
340518/100	0,5	● —	100
340519/100	0,5	● —	100
340520/100	0,5	● —	100
340521/100	0,5	● —	100
340522/100	0,5	● —	100
340523/100	0,5	● —	100
340524/100	0,5	● —	100
340525/100	0,5	● —	100
340526/100	0,5	● —	100
340527/100	0,5	● —	100
340528/100	0,5	○ —	100
340529/100	0,5	○ —	100
340530/100	0,5	○ —	100
340531/100	0,5	● —	100
340532/100	0,5	● —	100
340533/100	0,5	● —	100
340534/100	0,5	○ —	100
340535/100	0,5	● —	100
340536/100	0,5	● —	100
340537/100	0,5	● —	100
340538/100	0,5	● —	100
340539/100	0,5	● —	100
340540/100	0,5	● —	100
340541/100	0,5	● —	100
340542/100	0,5	● —	100
340543/100	0,5	● —	100
340544/100	0,5	● —	100
340545/100	0,5	● —	100
340546/100	0,5	● —	100

3407513/100	0,75	● —	100
3407514/100	0,75	● —	100
3407515/100	0,75	● —	100
3407516/100	0,75	● —	100
3407517/100	0,75	● —	100
3407518/100	0,75	● —	100
3407519/100	0,75	● —	100
3407520/100	0,75	● —	100
3407521/100	0,75	● —	100
3407522/100	0,75	● —	100
3407523/100	0,75	● —	100
3407524/100	0,75	● —	100
3407525/100	0,75	○ —	100

340760/100	0,75	● —	100
340761/100	0,75	● —	100
340762/100	0,75	● —	100
340763/100	0,75	● —	100
340764/100	0,75	● —	100
340765/100	0,75	● —	100

341013/100	1	● —	100
341014/100	1	● —	100
341015/100	1	● —	100
341016/100	1	● —	100
341017/100	1	● —	100
341018/100	1	● —	100
341019/100	1	● —	100
341020/100	1	● —	100
341021/100	1	● —	100
341022/100	1	● —	100
341023/100	1	● —	100
341024/100	1	● —	100
341025/100	1	● —	100
341026/100	1	● —	100
341027/100	1	● —	100
341028/100	1	● —	100
341029/100	1	● —	100
341030/100	1	● —	100
341031/100	1	● —	100
341032/100	1	● —	100
341033/100	1	● —	100
341036/100	1	● —	100
341037/100	1	● —	100
341038/100	1	● —	100
341039/100	1	● —	100
341040/100	1	● —	100
341041/100	1	● —	100
341042/100	1	● —	100
341043/100	1	● —	100
341044/100	1	● —	100
341045/100	1	● —	100
341046/100	1	● —	100
341047/100	1	● —	100
341048/100	1	● —	100
341049/100	1	● —	100
341050/100	1	● —	100
341051/100	1	● —	100
341053/100	1	● —	100
341055/100	1	● —	100
341056/100	1	● —	100
341058/100	1	● —	100
341059/100	1	● —	100

341060/100	1		100	341083/500	1		500
341061/100	1		100	341097/500	1		500
341062/100	1		100	341105/500	1		500
341063/100	1		100	341107/500	1		500
341064/100	1		100	341513/100	1,5		100
341065/100	1		100	341514/100	1,5		100
341066/100	1		100	341515/100	1,5		100
341067/100	1		100	341516/100	1,5		100
341068/100	1		100	341517/100	1,5		100
341069/100	1		100	341518/100	1,5		100
341070/100	1		100	341519/100	1,5		100
341071/100	1		100	341520/100	1,5		100
341072/100	1		100	341521/100	1,5		100
341073/100	1		100	341522/100	1,5		100
341074/100	1		100	341523/100	1,5		100
341076/100	1		100	341524/100	1,5		100
341077/100	1		100	341525/100	1,5		100
341078/100	1		100	341533/100	1,5		100
341079/100	1		100	341534/100	1,5		100
341080/100	1		100	341536/100	1,5		100
341081/100	1		100	341537/100	1,5		100
341082/100	1		100	341538/100	1,5		100
341083/100	1		100	341539/100	1,5		100
341084/100	1		100	341540/100	1,5		100
341085/100	1		100	341541/100	1,5		100
341086/100	1		100	341542/100	1,5		100
341087/100	1		100	341543/100	1,5		100
341088/100	1		100	341544/100	1,5		100
341089/100	1		100	341545/100	1,5		100
341090/100	1		100	341546/100	1,5		100
341091/100	1		100	341519/500	1,5		500
341092/100	1		100	341520/500	1,5		500
341093/100	1		100	341533/500	1,5		500
341094/100	1		100	341534/500	1,5		500
341095/100	1		100	341535/500	1,5		500
341096/100	1		100	341536/500	1,5		500
341097/100	1		100	342012/100	2		100
341098/100	1		100	342013/100	2		100
341099/100	1		100	342014/100	2		100
341100/100	1		100	342015/100	2		100
341101/100	1		100	342016/100	2		100
341102/100	1		100	342017/100	2		100
341103/100	1		100	342018/100	2		100
341104/100	1		100	342019/100	2		100
341105/100	1		100	342020/100	2		100
341106/100	1		100	342021/100	2		100
341107/100	1		100	342022/100	2		100
341021/500	1		500	342023/100	2		100
341026/500	1		500	342024/100	2		100
341035/500	1		500	342025/100	2		100
341036/500	1		500	342026/100	2		100
341037/500	1		500	342027/100	2		100
341066/500	1		500	342028/100	2		100
341067/500	1		500	342029/100	2		100
341071/500	1		500	342030/100	2		100
341072/500	1		500	342031/100	2		100
341073/500	1		500	342032/100	2		100
341074/500	1		500	342034/100	2		100
341075/500	1		500				
341078/500	1		500				

342035/100	2		100
342036/100	2		100
342037/100	2		100
342038/100	2		100
342039/100	2		100
342040/100	2		100
342041/100	2		100
342042/100	2		100
342043/100	2		100



MONTAGESNOER H07V2-K
UNIPOLAR CABLE
EINADRIGE ANSCHLUSS UND STEUER LEITUNG

90°C - 450AC-750DC

33699150	1,5		100
33699151	1,5		100
33699152	1,5		100
33699153	1,5		100
33699154	1,5		100
33699155	1,5		100
33699156	1,5		100
33699157	1,5		100
33699158	1,5		100
33699159	1,5		100
33699250	2,5		100
33699251	2,5		100
33699252	2,5		100
33699253	2,5		100
33699254	2,5		100
33699255	2,5		100
33699256	2,5		100
33699257	2,5		100
33699400	4		100
33699401	4		100
33699402	4		100
33699403	4		100
33699404	4		100
33699405	4		100
33699600	6		100
33699601	6		100
33699100	10		100
33699101	10		100



HALOGEENVRIJE VERTINDE KABELS
HALOGENFREE TINNED CABLE
HALOGENFREIES VERZINNTES KABEL

90 °C LLOYDS

nr.		mm ²	reel / rolle / haspel
33777050/r		0,50	100
33777050/z		0,50	100
33777075/r		0,75	100
33777075/z		0,75	100
33777001/r		1,00	100
33777001/z		1,00	100
33777150/r		1,50	100
33777150/z		1,50	100
33777250/r		2,50	100
33777250/z		2,50	100
33777400/r		4,00	100
33777400/z		4,00	100
33777600/r		6,00	100
33777600/z		6,00	100
33777100/r		10	100
33777100/z		10	100



COAX KABEL **COAX CABLE**
KOAXIAL KABEL

nr.	soort	reel / rolle / haspel
30-21700005	50 OHM RG 213	50
3366650	50 OHM (marifoon) RG58	100
3366125	75 OHM H125 catv	100
3366675	75 OHM (tv-kabel) RG59	100
90-99990030	50 OHM Aircell 7	100



SOLAR KABEL **SOLAR CABLE**
SOLAR KABEL

nr.	kleur	mm ²	reel / rolle / haspel
33123414		4	100/500
33123404		4	100/500
33123616		6	100/500
33123606		6	100/500



PVC KABEL H05VV-F GEEL
TRIPOLAR POWER CABLE YELLOW
STROMKABEL GELBE FÜR DIE AC 230V

300/500 volt.

nr.		mm ²	reel / rolle / haspel
3367315		3 x 1,5	100
3367315/500		3 x 1,5	500
3367325		3 x 2,5	75
3367325/500		3 x 2,5	500
3367304		3 x 4	50
3367306		3 x 6	50
3367525		5 x 2,5	50



GRIJZE PVC KABEL H05VV-F
TRIPOLAR POWER CABLE GREY
STROMKABEL GRAU FÜR DIE AC 230V

300/500 volt

nr.		mm ²	reel / rolle / haspel
336782075		2 x 0,75	100
336782075/500		2 x 0,75	500
33678215		2 x 1,5	100
33678215/500		2 x 1,5	500
33678225		2 x 2,5	100
33678225/500		2 x 2,5	500
33678315		3 x 1,5	100
33678415		4 x 1,5	100
33678515		5 x 1,5	50
33678204		2 x 4	50
33678206		2 x 6	50
33678715		7 x 1,5	100



PVC KABEL H05VV-F GEEL
TRIPOLAR POWER CABLE YELLOW
STROMKABEL GELBE FÜR DIE AC 230V
IEC 60332-1-2 / IEC 60332-3-24

300/500 volt.

nr.		mm ²	reel / rolle / haspel
95367315		3 x 1,5	100
95367325		3 x 2,5	75

Indien kabels gebundeld of door een bedradingskoker gelegd worden dienen kabels aan de strengere eis van de IEC 60332-3 te voldoen.

When cables are bundled or put trough a cable tray the cable has to perform according to the requirements of the IEC 60332-3.

Wenn Kabel gebündelt oder durch einen Kabelstreifen geführt werden, müssen die Kabel den strengen Anforderungen der IEC 60332-3 entsprechen.



H07RN-F NEOPREENKABEL
NEOPRENE CABLE
NEOPREN KABEL

ZEER SOEPEL / VERY FLEXIBLE / EXTREM FLEXIBEL

nr.		mm ²	reel / rolle / haspel
3366215		2 x 1,5	50
3366315		3 x 1,5	50
3366415		4 x 1,5	50
3366515		5 x 1,5	50
3366225		2 x 2,5	50
3366325		3 x 2,5	50
3366425		4 x 2,5	50
3366525		5 x 2,5	50
3366204		2 x 4	50
3366304		3 x 4	50
3366404		4 x 4	50
3366306		3 x 6	50
3366310		3 x 10	50



ZWARTE AUTOKABEL H05VV-F
TRIPOLAR POWER CABLE BLACK
STROMKABEL SCHWARZ FÜR DIE AC 230V

nr.		mm ²	reel / rolle / haspel
30-29450		2 x 0,75	100
30-29484		2 x 1,5	100
30-29485		2 x 2,5	100
30-29452		3 x 0,75	100
30-29468		3 x 1,5	100
30-29478		3 x 2,5	75
30-29525		5 x 2,5	50
30-29701	7 aderig:	7 x 1	50
30-29114	14 aderig:	9 x 1,5	50
		5 x 2,5	



BLADZIJDE / PAGE / ZEITE 29 - 31



LUIDSPREKER KABEL **SPEAKER CABLE**
LAUTSPRECHER KABEL

nr		mm ²	reel / rolle / haspel
33662075	●●	2 x 0,75	100
3368215	●●	2 x 1,5	100
3368225	●●	2 x 2,5	100



PLATTE PVC KABEL **FLAT CABLE** **FLACHKABEL**

nr		mm ²	reel / rolle / haspel
33667075	●●	2 x 0,75	100
3366710	●●	2 x 1	100
3366715	●●	2 x 1,5	100
3366725	●●	2 x 2,5	100
33667075/500	●●	2 x 0,75	500
3366710/500	●●	2 x 1	500
3366715/500	●●	2 x 1,5	500
3366725/500	●●	2 x 2,5	500



RONDE VERTINDE KABEL
TINNED TRIPOLAR ROUND CABLE
VERZINTE MEHRADERIG RUNDES KABEL

BLACK SHEATHED / AUSSENMANTEL SCHWARZ / ZWART OMHULD

nr		mm ²	reel / rolle / haspel
3388215	●●	2 x 1.5	100
3388315	●●●	3 x 1.5	100
3388415	●●●○	4 x 1.5	100
3388415/500	●●●○	4 x 1.5	500
3388225	●●	2x 2.5	100
3388204	●●	2 x 4	100



TWINFLEX ACCUKABEL PVC ROOD/ZWART
BIPOLAR BATTERYCABLE RED/BLACK
DOPELT BATTERIEKABEL ROT/SCHWARZ

nr	soort	mm ²	reel / rolle / haspel
3368804	twin	2 x 4	50
3368806	twin	2 x 6	50
3368810	twin	2 x 10	50
3368816	twin	2 x 16	50
3368825	twin	2 x 25	25
3368835	twin	2 x 35	25
3368850	twin	2 x 50	25
drum			
3368804/500	twin	2 x 4	500
3368806/500	twin	2 x 6	500
3368810/500	twin	2 x 10	500
3368816/500	twin	2 x 16	500

Op verzoek / on request / auf Anfrage 2 x 70mm² en 2 x 95 mm²



PU WALSTROOMKABEL HO5/7BQ-F GEEL
TRIPOLAR SCORE POWER CABLE HO5/7BQ-F YELLOW
LANDKABEL HO5/7BQ-F GELB

nr.	mm ²		belastbaar tot / taxable upto steuerpflichtig bis zu	reel / rolle / haspel
33668315	3 x 1,5	●●●	10 A	50
33668325	3 x 2,5	●●●	16 A	50
33668304	3 x 4	●●●	25 A	50
33668306	3 x 6	●●●	32 A	50
33668310	3 x 10	●●●	40 A	50
33668316	3 x 16	●●●	50 A	50

STUURSTROOM KABELS
CONTROL CABLE
STEUER - (UNGESCHIRMT) LEITUNG

Nominale spanning: 300/500 volt



nr.		mm ²	reel / rolle / haspel
LiYY 215	● 1,2	1.5	100
LiYY 225	● 1,2	2.5	100
LiYY1215	● 1 > 11 + ●	1.5	50
LiYY3075	● 1,2 + ●	3 x 0,75	100
LiYY3075C	●●○	3 x 0,75	100
LiYY401	● 1 > 3 + ●	4 x 1	100
LiYY315	● 1,2 + ●	3 x 1,5	100
LiYY415	● 1 > 3 + ●	4 x 1,5	100
LiYY515	● 1 > 4 + ●	5 x 1,5	100
LiYY715	● 1 > 7	7 x 1,5	100
LiYY325	● 1,2 + ●	3 x 2,5 mm ²	100

STUURSTROOM KABELS AFGESCHERMD
CONTROL CABLE SHIELDED
STEUER - (GESCHIRMT) DATENLEITUNG

		mm ²	reel / rolle / haspel
LiYCY2075	● 1,2	2 x 0,75	100
LiYCY225	● 1,2	2 x 2,5	100
LiYCY315	● 1,2 + ●	3 x 1,5	100
LiYCY415	● 1 > 3 + ●	4 x 1,5	100
LiYCY715	● 1 > 6 + ●	7 x 1,5	100

PU KABEL BEHOREND BIJ DE MP INLET
SHORE POWER CABLE AND PLUG WITH BUILT IN LEDLIGHT
LANDANSCHLUSS MIT MP STECKER MIT LEDLEUCHTE

1 uiteinde voorzien van een gele MP inlet stecker met led;
 andere uiteinde voorzien een CEE stecker voor de walaansluiting.

nr.	mm ²	max bel./maxable upto steuerplichtig bis zu	reel / rolle / haspel
3556315	3 x 1,5	10A	15
3557325	3 x 1,5	10A	25
3552823	3 x 2,5	16A	5
3558315	3 x 2,5	16A	15
3559325	3 x 2,5	16A	25
3552836	3 x 4	25A	15
3552832	3 x 4	25A	25
3552837	3 x 6	32A	15
3552838	3 x 6	32A	25
3552851	3 x 10	50A	15
3552852	3 x 10	50A	25



COMPLEET AC SYSTEEM 16A BASISKIT **BASIC POWERSYSTEM**
KOMPLETTES LANDANSCHLUSS SYSTEME

1 x RVS inlet, 1 x walstroom kabel 3 x 1,5mm² 15 meter, 2-voudig stopcontact, aardlek in kast, verbindingkabel 1 x 1 meter en 1 x 2 meter.

Plug-and-play systeem

Bestelnummer: 35AC16B



COMPLEET AC SYSTEEM 16A PROKIT **PROFFESIONAL POWER**
SYSTEM - KOMPLETTES LANDANSCHLUSS SYSTEME

1 x RVS inlet, 1 x walstroom kabel 3 x 2,5mm² 25m, Interne kabel 1 x 1m en 1 x 3m, 2 x 2m en 2 x 5m, connectiekabel 2 x 3m voor lader + boiler, groepenkast met 3 x 16A/30mA zekering automaat, 1 x WCD IP44, 3 x WCD flush en 1 x Galvanische isolator.

Plug-and-play systeem

Bestelnummer: 35AC16PRO



COMPLEET AC SYSTEEM 16A
VOOR KLEINE BOTEN / FOR SMALL BOATS / FÜR KLEINE BOTE

nr.	omschrijving	lengte
35MP16P	1x kunststof verchromde inlet, aardlek in kast en 1x walstroom kabel 3 x 1,5mm ²	15 meter
35MP16P/25	1x kunststof verchromde inlet, aardlek in kast en 1x walstroom kabel 3 x 1,5mm ²	25 meter
35MP16P/RVS	1x RVS inlet, aardlek in kast en 1x walstroom kabel 3 x 1,5mm ²	15 meter
35MP16P/K	1x kunststof inlet, aardlek in kast en 1x walstroom kabel 3 x 1,5 mm ²	15 meter



ADAPTERSET

nr.	omschrijving	lengte
70022	Adapter cord set schuko to CEE	0,30 meter
70026	Adapter cord set CEE to schuko	0,30 meter
70024	Splitter CEE / twin socket	0,50 meter



MARINCO CONTRA CEE STEKKER
POWERCABLE FOR MARINCO SOCKETS
LANDANSCHLUSS KABELL FÜR MARINCO BORDSTECKDOSE

nr.	mm ²	reel / rolle / haspel
3552812	3 x 2,5	25 meter





MP LOSSE STEKKERS
MP PLUGS
MP STECKER

nr.	omschrijving	maximale belasting
35588816	MP stekker / plug / stecker	16A
35588832	MP stekker / plug / stecker	32A
35588850	MP stekker / plug / stecker	50A

MP INLET COMPLEET
MP SOCKET COMPLETE
MP BORDSTECKDOSE KOMPLETT

nr.	omschrijving	maximale belasting
3556624	230V rvs/stainless steel/edelstahlgehäuse	16A
35599916/CH	230V chroom/chrome/chrom	16A
35599916	230V kunststof/plastic/kunststoff	16A
3553216	230V rvs/stainless steel/edelstahlgehäuse	32A
3555050	230V rvs/stainless steel/edelstahlgehäuse	50A



RVS INLET MET SNOER
SOCKET WITH CORD
BORDSTECKDOSE MIT KABEL
TBV 35AC EN 35 MP

nr.	Omschrijving	maximale belasting
355AC16-01	rvs/stainless steel edelstahlgehäuse	16A



MP WCD SCHUKO MET RVS KLEP
SCHUKO OUTLET SOCKET STAINLESS STEEL
EINBOU-SCHUKO-STECKDOSE
EDELSTAHLGEHAUSE

nr.	Omschrijving	maximale belasting
3556625	WCD schuko met RVS klep	16A



CEE STEKKER (16A)

nr.		e.h.
3456325	CEE stekker	1
3456326	CEE contra stekker	1
3456327	Schuko adapter to CEE	



PVC INLET MET SNOER
SOCKET WITH CORD
BORDSTECKDOSE MIT KABEL
TBV 35AC EN 35 MP

nr.	Omschrijving	maximale belasting
355AC16-01K	kunststof/plastic/kunststoff	16A

CCS BOAT INLET

nr.		e.h.
355CCS10	32A/480V	1



CEE STEKKER (32A)

nr.		e.h.
3456032	CEE stekker	1
3456132	CEE contra stekker	1



CEE STEKKER (32A)
SOCKET PLUG
CEE STECKER

nr.		e.h.
3456032	CEE stekker	1
3456132	CEE contra stekker	1

CCS BOAT INLET

nr.		e.h.
35532101	32A/400V	1



CLIPS T.B.V. WALSTROOM KABEL
CLIPS FOR POWER CABLE

nr.	omschrijving		verpakt per
70038	Railingclip	A	6
70040	Steigerclip 8mm	B	6

SHORE POWER SMARTBOX
FAST AND SAFE ELECTRIC BOAT CHARGING

Ratio Electric has developed the Shore Power Smart Box (SPSB) especially for the safe charging of your electric boat. The SPSB protects your boat (and the shore infrastructure) against overload while charging your batteries at maximum speed. The SPSB is equipped with the latest techniques from Electric Vehicle charging, such as load balancing, power sharing and earth leakage protection.

Load balancing
Load balancing is the technique that adjusts the charging speed of the battery charger to the remaining consumption in the boat. Modern boats can be equipped with luxury appliances such as refrigerator, induction cooker, espresso machine, washing machine, among others. The addition of all these appliances to the energy network increases the risk of overload. In case the overload takes too long, there is a risk of tripping of the shore circuits breakers. The SPSB continuously measures the total consumed power while in the event of overload the battery charging will be temporarily reduced.

Power sharing
Power sharing allows up to 4 electric boats to be charged simultaneously on 1 power source. The available power is distributed equally among the boats.

The SPSB is connected to the boat with a power cable that uses a type 2 male and female plug. Similar to electric vehicles. The male plug fits into the SPSB outlet and the female connector into the type 2 inlet of the boat. Charging only starts when both plugs are locked. The SPSB has an integrated earth leakage AC (30mA) and DC (5 mA) protection.

Shore Power Smart Box specifications:
Load capacity: 7,4kW or 22kW
Authorization: Plug & Play or key switch
Connection: Type 2 socket outlet
Dimensions: 400 x 250 x 105mm

Ratio
ELECTRIC



ELEKTRA
ELECTRICITY
STROM



KABELBESCHERMSLANG - DICHT
FLEXIBLE CORRUGATED TUBE - CLOSED
KABELSCHUTZSCHLAUCH - GESCHLOSSEN

nr.	Ø / ∅	reel / rolle / haspel
946004	4/7,20	100
946006	6/9,60	100
946009	9/13,25	100
946011	11/16,40	100
946013	13/18,40	100
946016	16/21,15	50
946019	19/24,00	50
946023	23/28,60	50
946026	26/31,65	50
946029	29/35,90	50
946032	32/39,50	25



T-CONNECTOR

nr.		
946304	7,5 x 7,5 x 7,5 mm	1
946305	10 x 10 x 10 mm	1
946306	13 x 13 x 13 mm	1
946307	10 x 13 x 10 mm	1
946308	10 x 7,5 x 7,5 mm	1
946309	13 x 10 x 13 mm	1
946310	7,5 x 10 x 7,5 mm	1



KABELBESCHERMSLANG - OPEN
FLEXIBLE CORRUGATED TUBE - OPEN
KABELSCHUTZSCHLAUCH - OFFEN

nr.	Ø / ∅	reel / rolle / haspel
946004.2	4/7,20	100
946006.2	6/9,60	100
946009.2	9/13,25	100
946011.2	11/16,40	100
946013.2	13/18,40	100
946016.2	16/21,15	50
946019.2	19/24,00	50
946023.2	23/28,60	50
946026.2	26/31,65	50
946029.2	29/35,90	50
946032.2	32/39,50	25



INSERTERTOOL

nr.	use for	
946400	8 mm	1
946401	15 mm	1
946402	20 mm	1
946403	32 mm	1



KABELBESCHERMSLANG - DICHT
FLEXIBLE CORRUGATED TUBE - CLOSED
KABELSCHUTZSCHLAUCH - GESCHLOSSEN

VOOR ELEKTRISCH VAREN / FOR ELECTRIC BOATS / FÜR E BOOT

nr.	Ø / ∅	reel / rolle / haspel
946011.4	11/15	100
946016.4	16/21	50
946021.4	21/25	50
946026.4	26/32	50
946032.4	32/39	50



GEWEVEN BESCHERMHOES
BRAIDED SLEEVES
GEFLOCHTENE UMMANTELUNG

nr.	mm	reel / rolle / haspel
948006	6	500
948008	8	350
948010	10	350
948012	12	300
948020	20	200
948020/50	20	50
948020/100	20	100
948030	30	150
948050	50	100

nr.	mm	doos/box/dose
948003/10	3	10 meter
948006/10	6	10 meter
948008/10	8	10 meter
948010/10	10	10 meter
948012/8	12	8 meter
948020/8	20	8 meter
948030/5	30	5 meter
948050/3	50	3 meter



FLEX SPIRAAL KABELBESCHERMING
FLEXIBLE SPIRAL
SPIRALSCHUTZ FÜR STROMKABEL

nr.	mm	reel / rolle / haspel
8881216	12x16	50
8882025	20x25	50
8882732	27x32	50
8883540	35x40	50

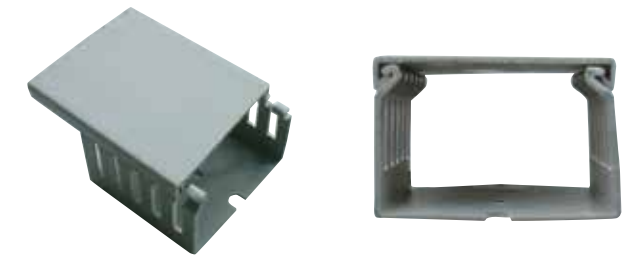

BEDRADINGSKOKER OPEN
WIRING DUET OPEN
VERDRÄHTUNGS KANAL OFFEN

nr.	↑	↔	doos/box/dose
3323453	40	40	24 x 2 meter
3323454	40	60	18 x 2 meter
3323456	60	30	16 x 2 meter
3323458	60	60	16 x 2 meter
3323460	60	100	8 x 2 meter

Andere maten op aanvraag leverbaar.
Other sizes available on request.
Andere Größen auf Anfrage erhältlich.

Verkoop alleen per volle doos i.v.m. transportschade
Only sale by box
Nür verkauf in dose



DELPHINUS KABELBESCHERMING
HOSES FOR PROTECTION
SCHLAUCHE FÜR KABELSCHUTZ

nr.	Ø	∅	reel / rolle / haspel
4500035	35	41	50
4500038	38	45	50
4500050	50	57	50

KABELSCHOENEN CONFORM DIN 40500
POWERLUGS **KABELSCHUHE**



nr.	mm ²	gat/hole/loch	vpe
3450606	6	M6	20
3450608	6	M8	20
3450610	6	M10	20
3451005	10	M	20
3451006	10	M6	20
3451008	10	M8	20
3451010	10	M10	20
3451012	10	M12	20
3451606	16	M6	20
3451608	16	M8	20
3451610	16	M10	20
3451612	16	M12	20
3452506	25	M6	20
3452508	25	M8	20
3452510	25	M10	20
3452512	25	M12	20
3453506	35	M6	20
3453508	35	M8	20
3453510	35	M10	20
3453512	35	M12	20
3455006	50	M6	10
3455008	50	M8	10
3455010	50	M10	10
3455012	50	M12	10
3457006	70	M6	10
3457008	70	M8	10
3457010	70	M10	10
3457012	70	M12	10
3459508	95	M8	10
3459510	95	M10	10
3459512	95	M12	10
34512008	120	M8	10
34512010	120	M10	10
34512012	120	M12	10
34512014	120	M14	10
34515010	150	M10	10
34515012	150	M12	10
34515016	150	M16	10
34518510	185	M10	10
34518512	185	M12	10
34518516	185	M16	10

KABELSCHOENEN 90 GRADEN



nr.	mm ²	gat/hole/loch	vpe
3441006	10	M6	5
3441008	10	M8	5
3441010	10	M10	5
3441606	16	M6	5
3441608	16	M8	5
3441610	16	M10	5
3442506	25	M6	5
3442508	25	M8	5
3442510	25	M10	5
3443506	35	M6	5
3443508	35	M8	5
3443510	35	M10	5
3445006	50	M6	5
3445008	50	M8	5
3445010	50	M10	5
3447008	70	M8	5
3447010	70	M10	5
3449508	95	M8	5
3449510	95	M10	5

DOORVERBINDER
HEAD POWERJOINT **KABELVERBINDER**

nr.	omschrijving	vpe
3451000	10 mm ²	5
3451600	16 mm ²	5
3452500	25 mm ²	5
3453500	35 mm ²	5
3455000	50 mm ²	5
3457000	70 mm ²	5
3459500	95 mm ²	5



KABELSCHOENSTIFT
CABLE LUG PIN **KABELSCHUHSTIFT**

nr.	omschrijving	vpe
346010	10 mm ²	5
346016	16 mm ²	5
346025	25 mm ²	5
346035	35 mm ²	5
346050	50 mm ²	5
346070	70 mm ²	5
346095	95 mm ²	5



KABELSCHOEN 45 GRADEN **POWERLUG** **KABELSCHUHE**



nr.	mm ²	gat/hole/loch	vpe
3421005	10	M5	5
3421006	10	M6	5
3421008	10	M8	5
3421606	16	M6	5
3421608	16	M8	5
3421610	16	M10	5
3422506	25	M6	5
3422508	25	M8	5
3422510	25	M10	5
3422512	25	M12	5
3423506	35	M6	5
3423508	35	M8	5
3423510	35	M10	5
3425006	50	M6	5
3425008	50	M8	5
3425010	50	M10	5
3425012	50	M12	5
3427008	70	M8	5
3427010	70	M10	5
3427012	70	M12	5
3429508	95	M8	5
3429510	95	M10	5
3429512	95	M12	5



KRIMPKOUS **HEATSHRINK TUBING** **SCHRUMPFSCHLAUCH**

nr.	omschrijving,	krimp/shrink		box
<i>richtlijn geschikt voor</i>				
946040	1,2	0,6	●	15 meter
946042			●	15 meter
946050	1,6	0,8	●	15 meter
946052			●	15 meter
946055	2,4	1,2	●	13 meter
946077			●	13 meter
946060	3,2	1,6	●	12 meter
946062	1,5mm ²		●	12 meter
946080	4,8	2,4	●	11 meter
946082	2,5 en 4mm ²		●	11 meter
946100	6,4	3,2	●	10 meter
946102	4 en 6 mm ²		●	10 meter
946120	9,5	4,8	●	7 meter
946122	10 en 16mm ²		●	7 meter
946140	12,7	6,4	●	6 meter
946142	25mm ²		●	6 meter
946150	15,9	8	●	5 meter
946152	35mm ²		●	5 meter
946160	19,1	9,55	●	5 meter
946162	50 mm ²		●	5 meter
946180	25,4	12,7	●	4 meter
946182	70, 95, 120 mm ²		●	4 meter

LIJMLAAG **GLUE LAYER** **KLEBESCHICHT**

nr.	omschrijving,	krimp/shrink		box
<i>richtlijn geschikt voor</i>				
9461032BL	3	1	●	5 meter
9461032RL	3	1	●	5 meter
9461048BL	4,8	1,6	●	4 meter
9461048RL	4,8	1,6	●	4 meter
9461064BL	6,4	2,1	●	3,5 meter
9461064RL	6,4	2,1	●	3,5 meter
9461079BL	7,9	2,6	●	3 meter
9461079RL	7,9	2,6	●	3 meter
9461095BL	9,5	3,2	●	3 meter
9461095RL	9,5	3,2	●	3 meter
9461127BL	12,7	4,2	●	2,5 meter
9461127RL	12,7	4,2	●	2,5 meter
9461150BL	15,4	5,1	●	2,5 meter
9461150RL	15,4	5,1	●	2,5 meter
9461191BL	19,1	6,4	●	2 meter
9461191RL	19,1	6,4	●	2 meter
9461254BL	25,4	8,4	●	1,5 meter
9461254RL	25,4	8,4	●	1,5 meter

KABELSCHOEN TYPE DIN 46235 DYNAMIC VERSIE **POWERLUG** **KABELSCHUHE**
DIN 10 VOOR LANGERE KABELINVOER EN GROTERE KLEM/PER.

nr.	mm ²	gat/hole/loch	vpe
3431608	16	M8	20
3431610	16	M10	20
3432508	25	M8	20
3432510	25	M10	20
3432512	25	M12	20
3433508	35	M8	20
3433510	35	M10	20
3433512	35	M12	20
3435008	50	M8	10
3435010	50	M10	10
3435012	50	M12	10
3435016	50	M16	10
3437008	70	M8	10
3437010	70	M10	10
3437012	70	M12	10
3437016	70	M16	10
3439510	95	M10	10
3439512	95	M12	10
3439516	95	M16	10
34312010	120	M10	10
34312012	120	M12	10
34312016	120	M16	10
34312020	120	M20	10
34315010	150	M10	10
34315012	150	M12	10
34315016	150	M16	10
34315020	150	M20	10
34318510	185	M10	10
34318512	185	M12	10
34318516	185	M16	10
34318520	185	M20	10
34324012	240	M12	10
34324016	240	M16	10
34324020	240	M20	10
34330016	300	M16	10
34330020	300	M20	10
34340016	400	M16	10
34340020	400	M20	10
34350020	500	M20	10
34362520	625	M20	10





DIVERSE KRIMPTANGEN CRIMPING TOOL

nr.	omschrijving
903050	tbv geïsoleerde gekleurde kabelschoen
903060	tbv geïsoleerde kabelschoen L + R
903070	hotseals
903080	Adereindhulzen 1,5mm - 4,0mm
903085	Adereindhulzen 6,0mm - 16,0mm



FÖHN VOOR HOTSEALS MET HITTE SCHILD

nr.	omschrijving	verp. eenheid
903090	Vulling d.m.v. wegwerp aansteker Filling by means of disposable lighter Befüllungsmittel Einwegfeurzeug	1st



PERSTANGEN PRESSING PLIERS PRESSZANGE

nr.	klembereik/clamping range/spanbereich
903460	6 t/m 50 mm ²
903470	10 t/m 120 mm ²



KABELSCHAAR CABLE CUTTER KABELSCHNEIDER

nr.	bereik/range/bereich
KM95	t/m 95mm ²
905010	tot 70mm ²



KABELSTRIPTANG CABLE STRIPPER ABISOLIERZANGE

nr.	bereik/range/bereich
4-28H	4 - 28 mm ²

ELEKTRISCHE PERSTANG ELECTRIC PRESSING PLIERS ELEKTRISCHE PRESSZANGE

10 - 300 MM² / 60 KN



nr.	omschrijving
3459898	60 mini elek. 6 - 150



nr.	omschrijving
3459090	Kabelsnijder/Cable cutter/Kabelschneider SFK 45

TANG VOOR RVS BUNDELBANDEN PLIERS FOR STAINLESS STEEL CABLE TIES ZANGE FÜR KABELBINDER AUS EDELSTAHL

BLADZIJDE 32: RVS KABELBANDJES
PAGE 32: STAINLESS STEEL CABLE TIES
ZEITE 32: NIROKABELBINDER



nr.	e.h.
429	1



HANDHYDRAULISCHE PERSTANG VOOR KABELSCHOENEN MANUALHYDRAULIC PRESSING TONGS FOR POWERLUG MANUELLE HYDRAULISCHE PRESSZANGE FÜR KABELSCUHE

nr.	e.h.
903480	1st

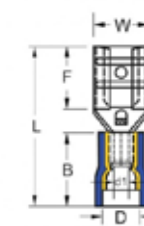

VLAKSTEKERHULS GEISOLEERD PRE ISOLATED BLADE CONNECTOR - VORISOLIERTE STECKDOSE

Ar.nr	EH	maat	W	F	L	B	D	d1
100020	100	2.8x0.8	3,2	6,5	19	10,5	3,8	1,7
100050	100	4.8x0.8	5	6,4	19,4	10,5	3,8	1,7
100100	100	6.3x0.8	6,6	7,5	20,8	10,5	3,8	1,7
152000	100	2.8x0.5	3,2	6,5	19	10,5	4,7	2,3
100380	100	4.8x0.5	5	6,4	19,4	10,5	4,7	2,3
100460	100	6.3x0.8	6,6	7,5	20,8	10,5	4,7	2,3
101000	100	6.3x0.8	6,6	7,5	23,3	13	6,2	3,4

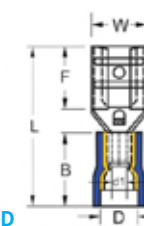

VLAKSTEKERHULS VOLLEDIG GEISOLEERD FULLY ISOLATED BLADE CONNECTOR VOLSTÄNDIG VORISOLIERTE FLACHSTECKER

Ar.nr	EH	maat	W	F	L	B	D	d1
101270	100	6.3x0.8	6,6	7,5	21,8	10,5	3,8	1,7
101310	100	6.3x0.8	6,6	7,5	22,2	10,5	4,7	2,3
101320	100	6.3x0.8	6,6	7,5	24,2	12,5	6,2	3,4

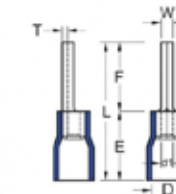

PENSTEKER MALE PLUGS PRE ISOLATED - STECKER VORISOLIERT

Ar.nr	EH	W	F	L	E	D	d1	T
100160	100	1.9	10	19,8	10	4	1,7	0,75
100550	100	1,9	12	21,8	10	4,5	2,3	0,8
101050	100	2.7	14	27	13	6,4	3,4	1,0



VLAKSTEKER FLAT PLUG - FLACH STECKER

Ar.nr	EH	maat	W	F	L	B	D	d1
100030	100	2.8x0.8	2,8	6,6	19,2	10,5	3,8	1,7
100110	100	6.3x0.8	6,3	7,7	21,8	10,5	3,8	1,7
100480	100	6.3x0.8	4,8	6,7	19,8	10,5	4,7	2,3
100990	100	6.3x0.8	6,3	7,7	24	13	6,2	3,4

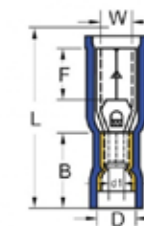

RONDSTEKERHULS FEMALE ROUNDPLUG - ENDPOL

Ar.nr	EH	W	F	L	B	D	d1
100090	100	3,9	7	23,3	10,5	3,8	1,7
100450	100	4,9	7	23,3	10,5	4,7	2,3
100980	100	4,9	7	25,1	12,5	6,2	3,4



RONDSTEKER MALE CILINDRED TERMINAL MALE - ZILINDERFÖRMIG ENDPOL

Ar.nr	EH	W	F	L	B	D	d1
100080	100	4	8,5	21,5	10,5	3,8	1,7
100440	100	5	8,5	21,2	10,5	4,7	2,3
100970	100	5	8,5	24	13	6,2	3,4

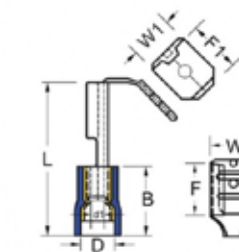

GEISOLEERDE VLAKSTEKERHULS MET EXTRA TAB PIGGY BACK - VORISOLIERT DOPPEL FASTON

Ar.nr	EH	maat	W	W1	F	F1	L	B	D	d1
100120	100	6.3x0.8	6,6	6,35	8	8,2	22,5	10,5	3,8	1,7
100470	100	6.3x0.8	6,6	6,35	8	8,2	22,5	10,5	4,7	2,3
101005	100	6.3x0.8	6,6	6,35	8	8,2	24	13	6,2	3,4



RINGKABELSCHOEN
PRE ISOLATED EYE - VORISOLIERTE KABELHÜLZEN

Ar.nr	EH	d2	d3	l	d1	d4	a	S
100180	100	3,2	6	16	1,6	4	10	0,8
100270	100	4,3	8	17	1,6	4	10	0,8
100320	100	5,3	10	18	1,6	4	10	0,8
100350	100	6,5	10	18	1,6	4	10	0,8
100360	100	8,4	14	22	1,6	4	10	0,8
100140	100	10,5						0,8
100590	100	3,2	6	16	2,3	4,5	10	0,8
100680	100	4,3	8	17	2,3	4,5	10	0,8
100730	100	5,3	10	19	2,3	4,5	10	0,8
100770	100	6,5	11	21	2,3	4,5	10	0,8
100780	100	8,4	14	22	2,3	4,5	10	0,8
100510	100	10,5	15	22	2,3	4,5	10	0,8
101100	100	4,3	8	21	3,6	6,3	13	1
101150	100	5,3	10	22	3,6	6,3	13	1
101180	100	6,5	11	22	3,6	6,3	13	1
101200	100	8,4	14	26	3,6	6,3	13	1
101030	100	10,5	18	28	3,6	6,3	13	1



RECHTE VORK KABELSCHOEN
PRE ISOLATED FORKEYE - VORISOLIERTE HÜLZEN

Ar.nr	EH	d2	d3	l	d1	d4	a	S
100640	100	4,3	6,8	17	2,3	4,5	10	0,8
100700	100	5,3	10	19	2,3	4,5	10	0,8
100740	100	6,4	11	21	2,3	4,5	10	0,8
101080	100	4,3	8	21	3,6	6,3	13	1
101110	100	5,3	10	22	3,6	6,3	13	1
101160	100	6,4	11	23	3,6	6,3	13	1



ADEREINDHULZEN DINTYPE
FERRULES - ADEREND HÜLZEN

Ar.nr	EH	mm2	F	L	B	D	C
720030/100	100	0,75	8	14	6,3	1,5	1,2
720040/100	100	1	8	14	6,3	1,7	1,4
720050/100	100	1.5	8	14	6,3	2	1,7
720051/100	100	1.5	15	14	6,3	2	1,7
720060/100	100	2.5	8	15	7,4	2,5	2,2
720061/100	100	2.5	18	15	7,4	2,5	2,2
720070/100	100	4	10	17	7,4	3,2	2,8
720080/100	100	6	12	20	8,5	3,9	3,5
720090/100	100	10	12	22	8,8	4,9	4,5



ADEREINDHULZEN DUBBEL
FERRULES DOUBLE - ADEREND HÜLZEN DOPPELT

Ar.nr	EH	mm2	F	L	B	D	C
720035/100	100	2x0.75	8	14,7	6,7	2,1	1,8
720045/100	100	2x1	8	15,1	7,1	2,4	2,1
720055/100	100	2x1.5	8	15,5	7,5	2,6	2,3
7200225/100	100	2x2.5	10	18,5	8,5	3,3	2,9
720075/100	100	2x4	12	23,1	11,1	4,2	3,8
720085/100	100	2x6	14	26,1	12,1	5,3	4,9



DOORVERBINDER - HEAD-HEAD JUMPER - BUSCHEN

Ar.nr	EH	maat	L	D	d1
100170	100	4.0	24,6	4	1,7
100580	100	4.5	24,6	4,5	2,3
101120	100	6.8	26,5	6,3	3,4

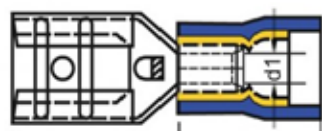

KLEURCODE / COLOR CODE / FARBCODE

Voor kabel / for cable/ für Kabel

- 0,5 - 1,5 mm²
- 1,0 - 2,5 mm²
- 2,5 - 6 mm²

Alle uitvoeringen zijn Easy entry - all with Easy entry
Alle versionen mit Easy entry



RINGKABELSCHOEN - RING CABLE LUG - RINGKABELSCHUH

Ar.nr	EH	mm ²	d2	W	L
1735015	100	0.5-1.5	5.3	8	32.8
1735016	100	0.5-1.5	6.4	11.6	38
1735018	100	0.5-1.5	8.4	11.6	38
1735010	100	0.5-1.5	10.5	13.6	41.6
1735025	100	1.5-2.5	5.3	9.5	31.8
1735026	100	1.5-2.5	6.4	12	37.5
1735028	100	1.5-2.5	8.4	12	36
1735030	100	1.5-2.5	10.5	13.6	40.2
1735056	100	4-6	6.4	12	39.4
1735058	100	4-6	8.4	15	44
1735060	100	4-6	10.5	15	44



RONDSTECKER MALE - ROUND PLUG - ZILINDERFORMIG

Ar.nr	EH	mm ²	W	D	L
1760055	100	0.5-1.5	4.0	5.5	33
1760060	100	1.5-2.5	5.0	6.0	33



RONDSTECKER FEMALE - ROND PLUG - ZILINDERFORMIG

Ar.nr	EH	mm ²	W	D	L
1760056	100	0.5-1.5	4.0	5.5	33
1760061	100	1.5-2.5	5.0	6.0	33



DOORVERBINDER - JUMPER - JUMPER

Ar.nr	EH	mm ²	d2	L
1710800	100	0.5-1.5	1.7	36
1720800	100	1.5-2.5	2.3	36
1730800	100	4-6	3.4	41



VLAKSTEKERHULS - FLATPLUG SLEEV - FLACHE STECKERHÜLSE

Ar.nr	EH	mm ²	W	D	L
1740055	100	0.5-1.5	6.6	5.5	34
1740060	100	1.5-2.5	6.6	6.0	34
1740081	100	4-6	6.6	8.1	35



HOTSEAL VLAKSTECKER - FLAT PLUG - FLACHSTECKER

Ar.nr	EH	mm ²	W	D	L
1745055	100	0.5-1.5	6.6	5.5	34
1745060	100	1.5-2.5	6.6	6.0	34
1745081	100	4-6	6.6	8.1	35



VLAKSTECKER VOLLEDIG GEÏSOLEERD
FLAT PLUG FULLY INSULATED - FLACHSTECKER VOLLISOLIERT

Ar.nr	EH	mm ²	W	D	L
1765065	100	0.5-1.5	6.35	6.5	38.5
1765070	100	1.5-2.5	6.35	6.5	39.5
1765075	100	4-6	6.35	7.5	39.5

KLEURCODE / COLOR CODE / FARBCODE

Voor kabel / for cable/ für Kabel

- 0,5 - 1,5 mm²
- 1,0 - 2,5 mm²
- 2,5 - 6 mm²

Alle uitvoeringen zijn Easy entry - all with Easy entry
Alle versionen mit Easy entry



MOLEX CONNECTOR STEKKER
MALE CONNECTOR **MANLICH STECKER**

KUNSTSTOF BEHUIZING

nr.	
10005005	2-polig
10005007	4-polig
10005009	6-polig
10005011	8-polig



MOLEX PIN STEKKER
MALE CONNECTION
STECKVERBINDUNG MÄNNLICH

nr.	omschrijving
10005012	te gebruiken in connector stekker for use in connector plug zum verwenden im Stecker



WATERDICHT VERBINDING
WATERTIGHT CONNECTOR
WASSERDICHT STECKVERBINDUNG

Verpakt per zakje / packed in bag / pro Beutel verpackt

nr.	
991000501	Connector F+M, terminal F+M, 2x wire seals
991000502	Connector F+M, 2 x terminal F+M, 4 x wire seals
991000503	Connector F+M, 3 x terminal F+M, 6 x wire seals
991000504	Connector F+M, 4 x terminal F+M, 8 x wire seals
991000505	Connector F+M, 5 x terminal F+M, 10 x wire seals
991000506	Connector F+M, 6 x terminal F+M, 12 x wire seals



MOLEX CONNECTOR CONTRA
CONNECTOR CONTRA **STECKER GEGER**

KUNSTSTOF BEHUIZING

nr.	
10005004	2-polig
10005006	4-polig
10005008	6-polig
10005010	8-polig



MOLEX PIN CONTRA
FEMALE CONNECTION
STECKVERBINDUNG WEIBLICH

nr.	omschrijving
10005013	te gebruiken in connector contra for use in connector contra zum verwenden mit steckverbindung weiblich



WAGO COMPACT

nr.	mm ²	vpe
42-2212411	1 kabel tot 4 mm	60
42-222412	2 kabel tot 4 mm	100
42-222413	3 cable up to 4 mm	50
42-222415	Kabel bis zum 4 mm	25

GELBOX
WATERDICHT - WATERTIGHT - WASSERDICHT

nr.	te gebruiken met compact / for use with compact	vpe
42-333412	42-222412	4
42-333413	42-222413	4
42-333415	42-222415	3



RVS KABELBANDJES
STAINLESS STEEL CABLE TIE
NIRO KABELBINDER

nr.	breedte x lengte	verp.eenheid
5800125	4,5 x 125	100
5800200	4,5 x 200	100
5800360	4,5 x 360	100
5800520	4,5 x 520	100
5800680	4,5 x 680	100
5800840	4,5 x 840	100
5800152M	8,0 x 152	50
5800200M	8,0 x 200	50
5800360M	8,0 x 360	50
5800520M	8,0 x 520	50
5800680M	8,0 x 680	50
5800840M	8,0 x 840	50



SCHROEFZADELS WIT **CLAMP SUPPORTS**
HALTERUNG FÜR KABELBINDER

nr.	verp. eenheid
952315 klein / small / klein	100
951510 groot / big / gross	100



SCHROEFZADELS ZWART **CLAMP SUPPORTS**
HALTERUNG FÜR KABELBINDER

nr.	verp. eenheid
962315 klein / small / klein	100
961510 groot / big / gross	100

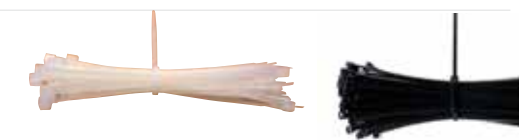

KABELBANDJES
CABLE TIES **KABELBINDER**

nr.	kleur	breedte x lengte	verp.eenheid
580020	○	2,5 x 98	100
580060	○	2,6 x 200	100
580080	○	3,6 x 140	100
580100	○	3,6 x 200	100
580130	○	4,5 x 160	100
580150	○	4,8 x 200	100
580180	○	4,8 x 360	100
580290	●	2,5 x 100	100
580330	●	2,5 x 203	100
580350	●	3,6 x 142	100
580360	●	4,8 x 160	100
580370	●	3,6 x 203	100
580400	●	4,6 x 160	100
580420	●	4,6 x 203	100
580450	●	4,6 x 368	100
580470	●	7,6 x 370	100
580490	●	7,6 x 450	100



PLAKZADELS
STICKY SADDLES FOR CABLE TIES
KLEBESÄTTEL FÜR KABELBINDER

nr.	b x l mm	kleur	verp. eenheid
580260	19 x 19	○	100
580270	27 x 27	○	100



KABELBAND MET SCHROEF OOG
CABLE TIE WITH SCREW EYE
KABELBINDER MIT SCHRAUBE AUGE

nr.	b x l mm	kleur	verp. eenheid
581110	2,5 x 110	○	100
581150	3,6 x 150	○	100
581200	4,8 x 200	○	100
581201	7,8 x 200	○	100
581313	7,6 x 313	○	100
581382	7,6 x 382	○	100

ACCUPOL KLEMMEN **BATTERY TERMINALS** **BATTERIE POLKLEMMEN**

AFDEKKAPPEN BLZ 43 - ISOLATING CAPS PAGE 43 - ISOLIERTEN HULSEN SEITE 43



nr.	pool	te gebruiken met	vpe
3323555	+	16 - 35 mm ²	10
3323556	-	16 - 35 mm ²	10
3323566	+	50 - 70 mm ²	10
3323567	-	50 - 70 mm ²	10



MET M10 DRAADEIND
WITH M10 THREADED END
MIT M10 GEWINDEENDE

nr.	pool	te gebruiken met	vpe
3313569	+	m10 kabelschoen-	10
3323568	-	ogen	10



MET M10 BOUT
WITH M10 BOLT
MIT M10 BOLZEN

nr.	pool	te gebruiken met	vpe
3388569	+	m10 kabelschoen-	10
3388568	-	ogen	10

EASY CLICK / MIT SCHNAPPMONTAGE

nr.	kleur	pool
4703000	●	+
4703050	●	-
4703100	●	-



DUBBEL
DOUBLE
DOPPELT

nr.	pool	te gebruiken met	vpe
3388672	+	50 - 70 mm ²	10
3388682	-	50 - 70 mm ²	10



MET MASSA ONDERBREKER
WITH GROUND BREAKER
MIT ERDUNGSLOSUNGKNOPF

nr.	e.h.
3323444	1



nr.	vpe
9660666 Accuklem voor blokzekering horizontale positie	1
9660667 Accuklem voor blokzekering verticale positie	1



nr.	vpe
9660660 Isolatiemoer M8	1



nr.	vpe
9660050 Blokzekering 50 amp	1
9660100 Blokzekering 100 amp	1
9660125 Blokzekering 125 amp	1
9660150 Blokzekering 150 amp	1
9660175 Blokzekering 175 amp	1
9660200 Blokzekering 200 amp	1
9660250 Blokzekering 250 amp	1
9660300 Blokzekering 300 amp	1



OPZETPOLEN
VOOR AGM- EN GEL-ACCUS

nr.	set
mrt 6666	M6 (set + en -)
mrt 8888	M8 (set + en -)



HOOFDSTROOM
SCHAKELAARS ON/OFF
HEAVY DUTY MAINE
BATTERY SWITCH
BATTERIE HAUPTSCHALTER

nr.	Continue/dauerbetrieb
97501	280A 5 sek/sec 2500A
97501S	Losse sleutel / sparekey / Ersatzschlüssel



HOOFDSTROOM
SCHAKELAARS ON/OFF
EASY BATTERY SWITCH
BATTERIE HAUPTSCHALTER
EINFACH

nr.	Continue/dauerbetrieb
97555	100A 5 sek/sec 500A
97555S	Losse sleutel / sparekey / Ersatzschlüssel



HOOFDSTROOM
SCHAKELAARS ON/OFF
BATTERY SWITCH
BATTERIE HAUPTSCHALTER

nr.	Continue/dauerbetrieb
97525	250A 5 sek/sec 2500A



STARTKLEM
STARTING CLAMP
STARTKLEMME

nr.	850A	●
4700001	850A	●
4700002	850A	●



STARTKLEM
STARTING CLAMP
STARTKLEMME

nr.	600A	●
4700005	600A	●
4700006	600A	●



STARTKLEM
STARTING CLAMP
STARTKLEMME

nr.	120A	●
4700003	120A	●
4700004	120A	●

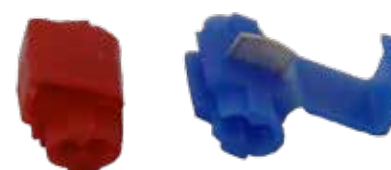

ZELFSTRIPPENDE
AFTAKKLEM
QUICK SPLICE TERMINALS
STECKKLEMME FÜR
ZWEGLEITUNG

nr.	mm ²	●
1000100	1,5 - 2,5	●
1000200	0,5 - 1	●





KAP VOOR SB50 WATERDICHT TE MAKEN
CAP FOR MAKING WATERTIGHT SB 50
FÜR WASSERDICHTER VERSCHLUSS SB 50

♀ **VRUW/FEMALE/WEIBLICH** ♂ **MAN/MALE/MANNLICH**

nr.			e.h
9588850/KAP	♀	IP65, Werktemp: -40 >35	1
9588850KAP/M	♂	16	1



CERTOPLAST PVC TAPE

nr.		rol / rolle	vpe
9992602	●	25 mtr	8
9992601	●	25 mtr	8

Overige kleuren op aanvraag
 other colors on request
 mehrere farben am anfrage

MG '86

nr.
 DGR-Spray Multispray



Multifunctioneel siliconenvrije vochtverdrijver, elektro cleaner, contactspray, vermindert ook wrijvingsweerstand, lost ook corrosie op, verwijdert tevens tectyl, parafin en vliegroest

Multifunctional silicone-free moisture repeller, electro cleaner, contact spray also reduces frictional resistance also dissolves corrosion also removes tectyl, paraffin and flash rust.

Multifunktionaler silikonfreier Feuchtigkeitsabweiser, Elektroreiniger, Kontaktspray reduziert auch den Reibungswiderstand löst auch Korrosion auf entfernt auch Tektyl-, Paraffin- und Blitzrost.



BATTERIJ STEKKERS
BATTERY CONNECTORS
BATTERIE STECKER

2 STUKS / PIECES/ STÜCKS

nr.		mm ²
9588850/G SB50 ●		16
9588850/R SB50 ●		16
9588175/G SB175 ●		50
9588350/G SB350 ●		70



TAPE TBV DASHBOARD
TAPE FOR ENGINE ROOM
KLEBEBAND FÜR MASCHINENRAUM

nr.		
9992514		textiel tape
9992538		fleece tape



HPX STETCH AND FUSE TAPE

nr.		vpe
9992301	25mm x 3m ●	1
9992302	25mm x 3m ○	1



STEEKZEKERINGHOUDER
 ATO MET CENTRALE AANVOER INCL. LED

FUSEHOLDERBOX
 WITH COMMON POSTIVE

SICHERUNGSKASTE
 MIT GEMEINSAMMEN PLUSPOL

nr.		
4202041	4 voudig/contacts/ kontakthalter	
4202061	6 voudig/contacts/ kontakthalter	
4202101	10 voudig/contacts/ kontakthalter	



ZEKERINGHOUDER
 ATO LED 4 VOUDIG

FUSEHOLDER
 ATO LED 4 VOUDIG

SICHERUNGSKASTE
 ATO LED 4 VOUDIG

nr.		e.h.
4203004		1



ZEKERINGHOUDER
 ATO DOORLUS 4 VOUDIG

FUSEHOLDER
 ATO DOORLUS 4 VOUDIG

SICHERUNGSKASTE
 ATO DOORLUS 4 VOUDIG

nr.		e.h.
4213004		1



STEEKZEKERINGHOUDER
 ATO, WATERDICHT MET LED

BLADE FUSEHOLDER
 WATERPROOF

HALTERUNG
 WASSERDICHT

nr.		
4202810	10 voudig/contacts/ kontakthalter	



ZEKERINGHOUDER
 ATO LED 6 VOUDIG

FUSEHOLDER
 ATO LED 6 VOUDIG

SICHERUNGSKASTE
 ATO LED 6 VOUDIG

nr.		e.h.
4203006		1



ZEKERINGHOUDER
 ATO DOORLUS 6 VOUDIG

FUSEHOLDER
 ATO DOORLUS 6 VOUDIG

SICHERUNGSKASTE
 ATO DOORLUS 6 VOUDIG

nr.		e.h.
4213006		1



STEEKZEKERINGHOUDER
 MET DUBBELE INVOER EN 1 CENTRALE MIN

FUSEHOLDERBOX
 WITH DOUBLE+ AND 1-

STECHERSICHERUNG
 MIT DOPPELT + UND 1-

nr.		
4203206	6 voudig/contacts/ kontakthalter	



ZEKERINGHOUDER
 ATO LED 10 VOUDIG

FUSEHOLDER
 ATO LED 10 VOUDIG

SICHERUNGSKASTE
 ATO LED 6 VOUDIG

nr.		e.h.
4203010		1



ZEKERINGHOUDER
 ATO DOORLUS 10 VOUDIG

FUSEHOLDER
 ATO DOORLUS 10 VOUDIG

SICHERUNGSKASTE
 ATO DOORLUS 10 VOUDIG

nr.		e.h.
4213010		1

**AFTAK ZEKERINGHOUDER
ADD A CIRCUIT FUSEHOLDER
ABZWEIGSICHERUNGHALTER**

nr	omschrijving	per
120170	Standaard zekering	10

**STEEKZEKERING
BLADE FUSES
FLUCHSTECKSICHERUNG**

ATO, PACKAGE 100

nr.	kleur	ampère
630010	●	1A
630020	●	2A
630030	●	3A
630040	●	4A
630050	●	5A
630075	●	7,5A
6300100	●	10A
6300150	●	15A
6300200	●	20A
6300250	●	25A
6300300	●	30A
6300350	●	35A
6300400	●	40A

**MICRO ZEKERINGEN
MICRO FUSE
MICRO SICHERUNG**

nr.	kleur	vpe	ampère
2992105	●	100	5A
2992100	●	100	10A
2992150	●	100	15A
2992200	●	100	20A

**ATO ZEKERING TREKKER
FUSE PULLER
SICHERUNGSZIEHER**

MET / WITH / MIT TESTER

nr	e.h.
640011	1

**STANDAARD STEEKZEKERINGHOUDER MET DRAAD
FUSEHOLDER WITH CABLE
SICHERUNGSHALTER MITKABEL**

WATERDICHT / WATERTIGHT / WASSERDICHT

nr	mm ²	vpe
120160	0,50 mm ² draad / cable / kabel	10
120159	0,75 mm ² draad / cable / kabel	10
120158	1 mm ² draad / cable / kabel	10
120157	2 mm ² draad / cable / kabel	10
120156	3 mm ² draad / cable / kabel	10

**ZEKERINGHOUDER
MET VLAKSTEKER AAN TE SLUITEN
FUSEHOLDER
FOR FLAT PLUG
SICHERUNGSHALTER
FÜR FLACHSTECKER**

nr	vpe
120154	10 stuks/pieces/Stuck

**AFTAK ZEKERINGHOUDER
T.B.V. MICROZEKERING
ADD A CIRCUITBREAKER
FOR MICROFUSE
ANZWEIGSICHERUNGSHALTER
FÜR MICROSICHERUNG**

nr	e.h.
120173	1

**ANL ZEKERINGHOUDERS
FUSEHOLDER
SICHERUNGSKÄSTEN
MET AFDEKKAP/WITH PROTECTION-
COVER/MIT SCHUTZKAPPE**



nr.	type	max ampère
2581010	enkel	250A



nr.	type	max ampère
2581012	dubbel	250A



nr.	type	max ampère
800740	enkel	250A



nr.	type	max ampère
2581020	enkel, koppelbaar single but linkable ein aber verlinkbaar	500A



**ANL ZEKERINGHOUDER
MET AFDEKKAP + RESERVE ANL HOUDER
FUSEHOLDER SPAREFUSE
SICHERUNGSKÄSTEN
FÜR EXTRA SICHERUNG**

nr.	type	max ampère
2581011	enkel	250



**ANL ZEKERINGEN
ANL FUSES
ANL STREIFENSICHERUNG MIT KERAMIKGEHÄUSE**

nr.	ampère
95805035	35A
95805040	40A
95805050	50A
95805063	63A
95805080	80A
95805100	100A
95805125	125A
95805135	135A
95805160	160A
95805175	175A
95805200	200A
95805225	225A
95805250	250A
95805275	275A
95805300	300A
95805355	355A
95805375	375A
95805400	400A
95805425	425A
95805500	500A



**ANL ZEKERINGHOUDER VOOR 6 ANL ZEKERINGEN
FUSEHOLDER FOR 6 ANL FUSES
SICHERUNGSKÄSTEN FÜR 6 ANL SICHERUNGEN**

nr.	type
2581016	6-voudig 123 mm x 252 mm



MINI ZEKERINGEN
MINI FUSES
MINI SICHERUNG

nr.	kleur	ampère
2991030	■	3
2991050	■	5
2991075	■	7,5
2991100	■	10
2991150	■	15
2991200	■	20
2991250	○	25



MEGA ZEKERINGEN
HIGH CAPACITY FUSE
HOCHLEISTUNGSSICHERUNG

nr.	kleur	ampère
9550060	●	60
9550080	●	80
9550100	■	100
9550125	■	125
9550150	■	150
9550175	○	175
9550200	■	200
9550225	■	225
9550250	■	250
9550300	■	300
9550400	■	400
9550500	■	500



MAXI ZEKERINGHOUDER
MAXI FUSEHOLDER
MAXI SICHERUNGSHALTER

nr	omschrijving
120154.2	met afdekkap with protection cap mit schutzkappe



MINI AFTAKKLEM ZEKERINGHOUDER
MINI ADD A CIRCUIT BREAKER
MINI ABZWEIGSICHERUNGHALTER

nr.	omschrijving
120171	Aftakklem zekering voor mini zekering
120172	Aftakklem zekering voor low profile mini zekering



MIDI ZEKERING
MIDI FUSES
MIDI SICHERUNG

nr.	kleur	ampère
9440030	■	30
9440040	■	40
9440050	■	50
9440060	■	60
9440080	○	80
9440100	■	100

MEGA ZEKERINGHOUDERS
HIGH CAPACITY FUSEHOLDER
HOCHLEISTUNGSSICHERUNGSHALTER
MET AFDEKKAP / WITH PROTECTION CAP / MIT SCHUTZKAPPE

nr.	omschrijving
9550555	Megazekeringhouder (L: 11, B:9, H:4)
9550666	1 x Mega > 4 x midi



MAXI ZEKERING
MAXI FUSE
MAXI SICHERUNG

nr.	kleur	ampère
6300020	■	20
6300030	■	30
6300040	■	40
6300050	■	50
6300070	■	70
6300080	○	80
63000100	■	100



MIDI ZEKERINGHOUDER
MIDI FUSE HOLDER
MIDI SICHERUNGSHALTER

nr	max vdc	M5
9440444	max 48 vdc	M5

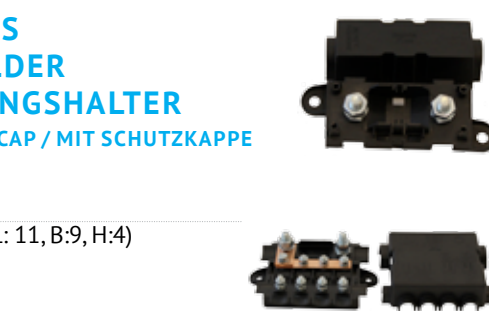

MAXI STEEKZEKERINGHOUDER
MAXI FUSE HOLDER
MAXI SICHERUNGSHALTER
MET KABEL / WITH CABLE / MIT KABEL

nr
120154.3



BOOSTER CONTACT PUNTEN

Max.: 48 vdc.

Max.: 350 amp @ 12 vdc

nr.		bout / bolt / bolzen
800376/r	●	m10
800376/z	●	m10



MINI KABELAANSLUITPUNT
POWERPOST JUNCTION
STROMKREISVERTEILBLOCK

nr.	vdc	amp
95805111	● 12>48	160 8
95805112	● 12>48	160 8
95805111/m	● 12>48	160 M8
95805112/m	● 12>48	160 M8
95805109	● 12>48	160 M10
95805110	● 12>48	160 M10



VERDEELSTRIP
MET AFDEKKAP
ELECTRIC TERMINAL BOARD
WITH COVER
SAMMELSCHIENE
MIT SCHUTZENKAPPE

nr.	vdc
9587713	12-voudig 12>48 ●
9587712	12-voudig 12>48 ●



BRACKET MOUNT KIT

nr.	bout / bolt / bolzen
800378/z	m10



MAXI KABELAANSLUITPUNT
POWERPOST JUNCTION
STROMKREISVERTEILBLOCK

nr.	vdc	amp
9587385	● 12>48	160 10
9587386	● 12>48	160 10
9587383	● 12>48	160 8
9587384	● 12>48	160 8
9587385/m	● 12>48	250 M10
9587386/m	● 12>48	250 M10



VERDEELSTRIP
BUSBAR TERMINAL BOARD
KLEIMLEISTE
10-VOUDIG

nr.	vdc
9587723	12>48 10-voudig ●
9587722	12>48 10-voudig ●
9587723/K	12>48 kap / cap ●
9587722/K	12>48 kap / cap ●

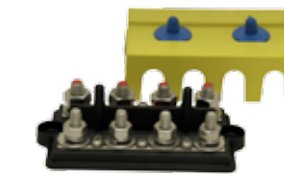

DUBBELVOUDIGE
VERDEELSTRIP HEAVY
DUTY BUSBAR TERMINAL
HOCHLEISTUNGSKLEMLEISTE
+ EN - / + AND - / PLUS UND MINUS

nr.	e.h.
800738	4 x + M10/ 4 x - M8 1



KABELAANSLUITPUNT
MET ONDERVERDELING
POWERPOST JUNCTION
WITH ROUND TERMINAL BOARD
STROMKREISVERTEILBLOCK
MIT 8 SAMMELSCHIENE

nr.			
800778/r	●	160A	m8
800778/z	●	160A	m8



VERDEELSTRIP MET AFDEKKAP
HEAVY DUTY BUSBAR
TERMINAL WITH COVER
HOCHLEISTUNGSKLEMMLEISTE
MIT SCHUTZENKAPPE

nr.	vdc
95874010/r	12>48 ● 4 x m10
95874010/z	12>48 ● 4x m10
95874008/r	12>48 ● 4 x m8
95874008/z	12>48 ● 4 x m8

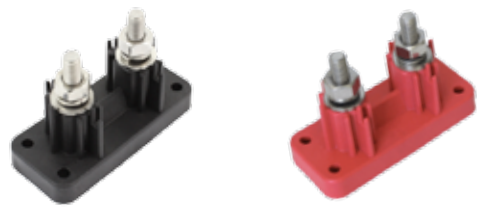

T-ZEKERINGHOUDER MET KAP
BESTEMD VOOR JIN ZEKERING
CLASS T FUSEHOLDER WITH PROTECTION CAP
FOR JIN FUSES
SICHERUNGKASTEN MIT SCHUTZKAPPE
FÜR JIN SICHERUNG

nr.		vdc
958735N8N14	●	12>48 vdc
958735N8N02	●	12>48 vdc

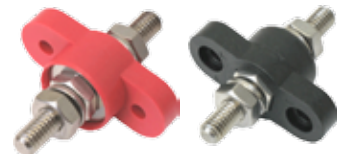

DOORVOER
POWER POST JUNCTIONBOX
ABZWEIG/DURCHGANGSVERBINDUNG

nr.	M	
80077231/r	8	●
80077231/z	8	●
80077237/r	10	●
80077237/z	10	●



4 PUNTS COMPACTE STROOMRAIL/BUSBAR
4 PUNTS COMPACTE STROOMRAIL/BUSBAR
4 PUNTS COMPACTE STROOMRAIL/BUSBAR

Belasting max : 12 vdc>210 A

nr.		omschrijving	vdc	eh
95807704N0N02	●	1 x ¼ + 3 x ¾	12>48	1
95807704N0N14	●	1 x ¼ + 3 x 5/16	12>48	1



HD KABELAANSLUITPUNT M10
HD POWERPOST JUNCTION
HD STROMKREISVERTEILBLOCK

nr.	vdc	max vdc	eh
95877510M0N02	● 12>48	12V>250A	1
95877510M0N14	● 12>48	12V>250A	1



VLAKSTEKKER STROOMRAIL
FLATPLUG BUSBAR
FLACHSTECKSCHIENE

20A per connectie

nr.	vdc	max vdc	eh
9580710N02	● 12>48	12V>250A	1
9580710N14	● 12>48	12V>250A	1

AFDEKKAPPEN - ISOLATING CAPS - ISOLIERTEN HULSEN

ACCUPOOLKLEMMEN BLZ 34 - BATTERY TERMINALS PAGE 34 - BATTERIE POLKLEMMEN SEITE 34



AANSLUITPUNT MET AFDEKKAP
WITH COVER
MIT SCHUTZENKAPPE

nr.	M	
80037602W/r	10	●
80037602W/Z	10	●



NORMAAL (LAAG MODEL)
NORMAL (LOW MODEL)
NORMAL (NIEDRIGES MODELL)

nr.		vpe
800316/r	●	10
800316/z	●	10



VOOR MEERDERE KABELS (HOOG MODEL)
FOR MULTIPLE CABLES (HIGH MODEL)
FÜR MEHRERE KABEL (HOHES MODELL)

nr.		vpe
800314/r	●	10
800314/z	●	10



ENKEL / SINGLE / EIND

nr.		vpe
800454/r	●	10
800454/z	●	10



DUBBEL / DOUBLE / DOPPELT

nr.		vpe
800451/r	●	10
800451/z	●	10



VOOR DRAADEIND
FOR THREADED END
FÜR GEWINDEENDE

nr.		vpe
800456/r	●	10
800456/z	●	10
800457/r	●	10
800457/z	●	10

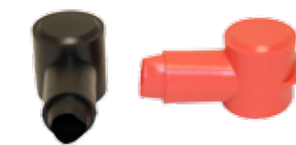

VOOR DYNAMO'S, LAADSTROOMVERDELERS EN STARTMOTOREN
verpakt per 10

nr.	mm	
800212N1/r	12	●
800212N1/z	12	●
800212N2/r	12	●
800212N2/z	12	●
800218/r	18	●
800218/z	18	●
800220/r	20	●
800220/z	20	●
800224/r	22	●
800224/z	22	●
800228/r	28	●
800228/z	28	●



VOOR 90° KABELSCHOENOGEN

nr.	mm²	vpe
800962/r	● 10/16	10
800962/z	● 10/16	10
800963/r	● 25	10
800963/z	● 25	10
800964/r	● 35/50	10
800964/z	● 35/50	10
800966/r	● 70	10
800966/z	● 70	10
800967/r	● 95	10
800967/z	● 95	10
800968/r	● 120	10
800968/z	● 120	10

Andere maatvoering op aanvraag leverbaar





KAST V.Z.V. TRANSPARANTE DEKSEL

nr.	omschrijving	maten L x B x D
6722002	2 modules	135 x 76 x 102
6722004	4 modules	190 x 112 x 106
6722008	8 modules	190 x 184 x 106
6722012	12 modules	250 x 256 x 140
6733002	2 modules zonder deksel	130 x 52 x 60
6733004	4 modules met deksel	200 x 122 x 95
6733008	8 modules met deksel	200 x 184 x 95
6733012	12 modules met deksel	200 x 256 x 95

DOORVERBINDRAIL/VERDEELKAMMEN

ALLEEN VOOR AUTOMATEN

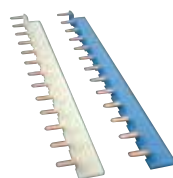

nr.	omschrijving
99G2L1BG	set Doorverbindrail



nr.	2 phase	8	10	24	omschrijving
5122908					lengte 72 mm
5122910					lengte 88 mm
5122924					Lengte 220 mm



DINRAIL T.B.V. AUTOMATEN DINRAIL FOR CIRCUITBREAKER DINRAIL FOR SCHUTZSCHALTER

nr.	omschrijving
15-4604	Per meter



AARDLEKAUTOMAAT B-KARAKTERISTIEK MCB DOUBLE LEAKAGE PROTECTOR MCB SCHUTZSCHALTER

nr.	omschrijving
64621610	B10A, 30mA, 1 P+N 6KA
64621630	B16A, 30mA, 1 P+N, 6KA
64621625	B25A, 30mA, 1 P+N 6KA
64510016	18mm B16A, 30mA, 1 P+N, 6KA



AARDLEKSCHAKELAAR B-KARAKTERISTIEK RCBO LEAKAGE PROTECTOR RCBO SCHULTZSCHALTER

nr.	omschrijving
64624030	40 ampère, 2-polig, 30mA, 10KA



INSTALLATIE AUTOMAAT 1 POLIG+N, 1 MODULE B-KARAKTERISTIEK 6KA (18MM) CIRCUITBREAKER SWITCH EINPOLIGER THERMISCH LEISTUNGSSCHUTZ

nr.	omschrijving
644206	6 ampère
644210	10 ampère
644216	16 ampère
644220	20 ampère
644225	25 ampère
644232	32 ampère
644240	40 ampère



INSTALLATIE AUTOMAAT 1 POLIG, 1 MODULE B-KARAKTERISTIEK 10KA CIRCUITBREAKER SCHUTZSCHALTER

nr.	ampère
641006	6
641010	10
641016	16
641020	20
641025	25
641032	32
641040	40
641050	50
641063	63

NIET VOOR DC
NOT FOR DC
NICHT FÜR DC



AARDRAIL EARTH RAIL ERDUNGSSCHIENE

nr.	lengte / length / Länge	max
15-4002	1 meter 56 M6	63A
15-4003	1 meter 40 M8	100A
15-4004	1 meter 30 M10	200A



AUTOMATISCHE ZEKERING CIRCUITBREAKER LEISTUNGSSCHALTER

nr.	amp
6412080	80
6412100	100
6412160	150
6412180	180
6412200	200

RECOMMENDED CABLE AND FUSE BREAKER

Inverter	Cable size < 3 meter	Cable size > 3 meter	Fuse breaker
12v 1500w	50 mm ²	95 mm ²	180 Amp
24v 1500w	35 mm ²	50 mm ²	80 Amp
12v 2000w	70 mm ²	120 mm ²	200 Amp
24v 2000w	50 mm ²	70 mm ²	100 Amp
12v 3000w	120 mm ²	180 mm ²	Not available
24v 3000w	70 mm ²	95 mm ²	160 Amp
48v 3000w	35 mm ²	50 mm ²	80 Amp

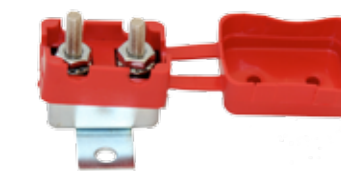

AUTOMATISCHE ZEKERING CIRCUITBREAKER LEISTUNGSSCHALTER

nr.	omschrijving
960001	Kapje rood t.b.v. automatische zekering 40A
960020	20A
960030	30A
960040	40A



ACCULADER
BATTERY CHARGER
LADEGERÄT

4 trapsacculader geschikt voor Natte-,Gel-,AGM- en LI Ion accu's
ook geschikt als power supply

4-stage battery charger suitable for lead batteries, gel batteries, AGM batteries and I-ION batteries also suitable as a power supply

4-stufiges Batterieladegerät für Bleibatterien, Gelbatterien, AGM-Batterien und I-ION-Batterien, die auch als Stromversorgung geeignet sind

nr.	
WSC1215	12vdc 15 A
WSC1230	2A 2x 30A



SCHEIDINGSRELAIS AUTOMATISCHE HERKENNING
SEPERATORRELAY AUTOMATIC RECOGNITION
TRENNRELAIS AUTOMATISCHER ERKENNUNG

nr.		max
DG-100SR	12/24	100A
DG-140SR	12/24	140A
DG-160SR	12/24	160A



ACCULADER
BATTERY CHARGER
LADEGERÄT

Acculader voor 3 accu's welke ook nog eens afzonderlijk zijn in te stellen, dus gelijktijdig bv. natte-gel-agm accu laden.

battery charger for 3 batteries which can also be set separately so simultaneously charge lead-gel or agm battery

Batterieladegerät für 3 Batterien, die auch separat eingestellt werden können, um gleichzeitig Blei-Gel- oder Agm-Batterie zu laden

nr.	
OC1260	12 vdc
OC2430	24 vdc



VERLIESVRIJE LAADSTROOMVERDELERS
BATTERY ISOLATOR
BATTERIEISOLATOR VERLUSTARMEN VERTEILUNG

Er zijn geen aanpassingen aan de dynamo nodig, ook niet voor dynamo's die herkenning nodig hebben.

nr.	accu output voor/for/zum	Dynamo/alternator leuchtmachin max
DG100/2IG	2 accusets/battery/batterie	100A
DG100/3IG	3 accusets/battery/batterie	
DG150/2IG	2 accusets/battery/batterie	150A
DG150/3IG	3 accusets/battery/batterie	
DG200/3IG	3 accusets/battery/batterie	200A
met 2 ingang - with 2 input - mit 2 eingang		
DG2M100/3	geen herkenning no IG connection keine verlustarmen verteilung	100A



ACCUBEWAKER
BATTERY GUARD
BATTERIE UBERWACHTER

nr.	
DG-040AB	40A
DG-060AB	60A



TUIMELSCHAKELAAR
TOGGLE SWITCH
KIPPSCHALTER

nr.				
723/B	12V	20A	●	M20
723/G	12V	20A	●	M20
723/R	12V	20A	●	M20



SIGARETTEN AANSTEKER CONTACTDOOS
12/24 VOLT OP EN INBOUW
POWERSOCKET BY WALL OR CEILING MOUNTING
STECKDOSE ZUR DECK- ODER WANDMONTAGE

nr.		e.h.
4202999	20 amp max	1



DUBBELE USB AANSLUITING
DUAL USB SOCKET
DOPPEL USB BUCHSE

nr.		e.h.
4202888	Dual USB aansluiting met Led en magnetische klepsluiting Vdc 12/24	1
4202993	USB inbouw 2.4a+2.4a max 12 vdc	1
4202994	Sigaretten aansteker inbouw 12/24 vdc	1
4202995	Inbouw paneel enkel	1
4202996	Inbouw paneel dubbel	1
4202997	Opbouw paneel enkel	1
4202998	Opbouw paneel dubbel	1





PVC- EN RUBBERPRODUCTEN
PVC AND RUBBER PRODUCTS
PVC- UND GUMMIPRODUKTE



**RUBBER
PROFILES**

2022 / 2023
**DE EXPERT IN
TPE RUBBERPROFIELEN**
RUBBER PROFIELEN VAN TOPKWALITEIT

+31 (0) 321 74 40 42
info@dgrubberprofiles.nl
www.dgrubberprofiles.nl

DG RUBBER PROFILES B.V.
Loofklapper 16a
8256 SL Biddinghuizen



**RUBBER
PROFILES**

WAAROM TPE?
TPE is een synthetisch rubber die bij kamertemperatuur elastische druk-en trekkracht kan weerstaan.
Daarnaast heeft TPE een lange levensduur en is goed bestendig tegen UV-licht, zout water en temperatuurverschillen.
TPE is in verhouding tot andere polymeren goed te bewerken en heeft daarom relatief voordelige matrijkskosten.

WAAROM DG RUBBER PROFILES?
Door onze ervaring met TPE extrusie kunnen wij bijna elke mogelijke vorm als profiel produceren en kunnen wij snel en goedkoop leveren. Wij kunnen ons rubber in alle mogelijke RAL kleuren leveren en in 4 verschillende hardheden.

Technical drawing showing dimensions: 80, 65, 30, 20, 25, 4, 6, 6, 23, 28.

+31 (0) 321 74 40 42
info@dgrubberprofiles.nl
www.dgrubberprofiles.nl

DG RUBBER PROFILES B.V.
Loofklapper 16a
8256 SL Biddinghuizen

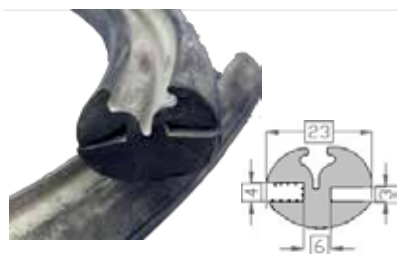

**RAAMRUBBER
SEALING WINDOWPROFILES
FENSTERGUMMI**

TPE
Tollerantie: ISO 3302-1 E2

nr.	rollengte / role / rolle
2015165/G	25 meter

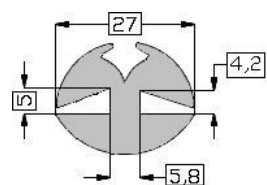

**RAAMRUBBER
SEALING WINDOWPROFILES
FENSTERGUMMI**

TPE
Tollerantie: ISO 3302-1 E2

nr.	rollengte / role / rolle
2014074/G	25 meter

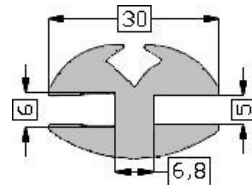

**RAAMRUBBER
SEALING WINDOWPROFILES
FENSTERGUMMI**

TPE
Tollerantie: ISO 3302-1 E2

nr.	rollengte / role / rolle
20181267/G	25 meter



**RAAMRUBBER
SEALING WINDOWPROFILES
FENSTERGUMMI**

EPDM
Tollerantie: ISO 3302-1 E2

nr.	rollengte / role / rolle
102745	25 meter

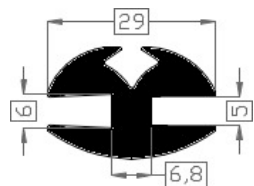

**RAAMRUBBER
SEALING WINDOWPROFILES
FENSTERGUMMI**

EPDM
Tollerantie: ISO 3302-1 E2

nr.	rollengte / role / rolle
1000056	25 meter



**RAAMRUBBER
SEALING WINDOWPROFILES
FENSTERGUMMI**

TPE
Tollerantie: ISO 3302-1 E2

nr.	rollengte / role / rolle
2014035	25 meter

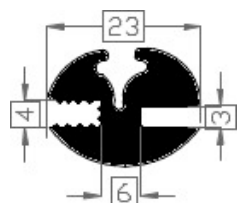

**RAAMRUBBER
SEALING WINDOWPROFILES
FENSTERGUMMI**

EPDM
Tollerantie: ISO 3302-1 E2

nr.	rollengte / role / rolle
1000034	25 meter

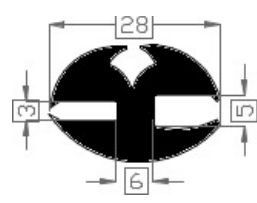

**RAAMRUBBER
SEALING WINDOWPROFILES
FENSTERGUMMI**

EPDM
Tollerantie: ISO 3302-1 E2

nr.	rollengte / role / rolle
1000053	25 meter



POSEIDON MARINE KIT

Langzaam drogende kit. Zeer geschikt voor TPE profielen.

nr.	vpe
8844468	per stuk of doos van 12 per piece or box of 12 pro Stück oder Schachtel mit 12 Stück



PEES- SPIERTREKKER

nr.	
1000018	Pees- spiertrekker t.b.v. raamrubbers



VULBIES - FILLERSTRIP - FÜLLROHR

PVC Profiel voor het afdekken van schroefjes in aluminiumramen.

nr.	mm	rollengte / role / rolle
1000011	zwart	13 100 meter
1000012	zilver metalic	13 100 meter

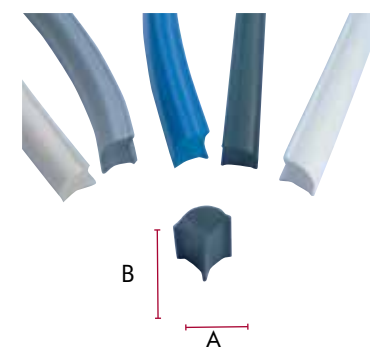

**PVC PEES T.B.V. RAAMRUBBERS
TENDON FOR WINDOWSEALS
FULLER FÜR FENSTERGUMMI**

STANDAARD - STANDARD - STANDARD

GROOT - BIG - GROSS

maten	rollengte / role / rolle
A: 8 mm	50 meter
B: 9 mm	

maten	rollengte / role / rolle
A: 9 mm	50 meter
B: 10 mm	

nr.	
1000006	○
1000007	●
1000008	●
1000009	●
1000010	●

1000071	●
1000081	●
1000091	●

**RUBBER
PROFILES**



SPONSRUBBER D-PROFIEL
NEOPRANE D
NEOPREN D

ZELFKLEVEND - SELF-ADHESIVE -
SELBSKLEBENDES

nr.	afm.	rollengte
75801412	14 x 12	100 meter
75801210	12 x 10	100 meter
75802217	21 x 17	50 meter
7580806	8 x 6	50 meter



SPONSRUBBER RECHTHOEK
NEOPRANE FOAM SEAL
NEOPREN

EPDM met rondom een huid, gesloten cel, 15 shoreA

nr.	afmeting	rollengte
7541503	15 x 3	100 meter
7542003	20 x 3	100 meter
7542503	25 x 3	50 meter
7541005	10 x 5	50 meter
7541505	15 x 5	50 meter
7542005	20 x 5	50 meter
7542505	25 x 5	50 meter
7543005	30 x 5	50 meter
7545005	50 x 5	25 meter
7541510	15 x 10	50 meter
7542010	20 x 10	50 meter
7542510	25 x 10	50 meter
7543010	30 x 10	25 meter
7544010	40 x 10	25 meter
7542015	20 x 15	25 meter
7542515	25 x 15	25 meter
7543015	30 x 15	25 meter
7543515	35 x 15	25 meter
7544015	40 x 15	25 meter
7543020	30 x 20	25 meter
7544020	40 x 20	25 meter
7543025	30 x 25	25 meter
7544030	40 x 30	25 meter



KROONBAND PROFILES FOR SEALING
GUMMIPROFIELE ZUM VERSIEGELN

MET KLEEFLAAG - SELF-ADHESIVE -
SELBSKLEBENDES

nr.	afm.	rollengte
75801508	15 x 8	50 meter



SPONSRUBBER ROND
NEOPRANE ROUND
NEOPREN

EPDM met rondom een huid, Gesloten cel, 15 shoreA

nr.	diameter	rollengte
7540006	Ø 6	100 meter
7540008	Ø 8	100 meter
7540010	Ø 10	50 meter
7540012	Ø 12	50 meter
7540015	Ø 15	50 meter
7540025	Ø 25	25 meter



SPONSRUBBER V-PROFIEL
NEOPRANE V-PROFILE
NEOPREN V-PROFIL

nr.	afm.	rollengte
7580555	16 x 15 mm	50 meter

Zelfklevend L-profiel
Self-adhesive L-profile
Selbstklebende L-profil

nr.	afm.	rollengte
7592019	20 x 19 mm	50 meter
7591615	16 x 15 mm	50 meter
7591211	12 x 11 mm	50 meter
7590807	8 x 7 mm	50 meter



SPONSRUBBER VIERKANT
NEOPRANE SQUARE
ABDICHT GUMMI

EPDM met rondom een huid, Gesloten cel, 15 shoreA

nr.	maat	rollengte
7540606	6 x 6	100 meter
7540808	8 x 8	100 meter
7541010	10 x 10	50 meter
7541212	12 x 12	50 meter
7541515	15 x 15	50 meter

CEL RUBBER STRIP **SELFADHESIVE RUBBER PROFILE**
SELBHALTEND GUMMIPROFIELE

EPDM, éénzijdig zelfklevend. Gesloten cel.

nr.	breedte mm	dikte mm	rollengte / role / rolle
7501003/10	10	3	10 meter
7501503/10	15	3	10 meter
7502003/10	20	3	10 meter
7502503/10	25	3	10 meter
7503003/10	30	3	10 meter
7501005/10	10	5	10 meter
7501505/10	15	5	10 meter
7502005/10	20	5	10 meter
7502505/10	25	5	10 meter
7503005/10	30	5	10 meter

7501003	10	3	160 meter
7501503	15	3	100 meter
7502003	20	3	60 meter
7502503	25	3	60 meter
7503003	30	3	40 meter
7503503	35	3	20 meter
7504003	40	3	20 meter
7501005	10	5	100 meter
7501505	15	5	60 meter
7502005	20	5	40 meter
7502505	25	5	40 meter
7503005	30	5	30 meter
7504005	40	5	20 meter
7504505	45	5	20 meter

7501006	10	6	80 meter
7501506	15	6	40 meter
7502006	20	6	40 meter
7502506	25	6	30 meter
7503006	30	6	20 meter
7503506	35	6	10 meter

7501010	10	10	50 meter
7501510	15	10	30 meter
7502010	20	10	20 meter
7502510	25	10	10 meter
7503010	30	10	10 meter
7503510	35	10	10 meter
7504010	40	10	10 meter

7502015	20	15	10 meter
7502020	20	20	10 meter
7502520	25	20	10 meter
7504020	40	20	10 meter

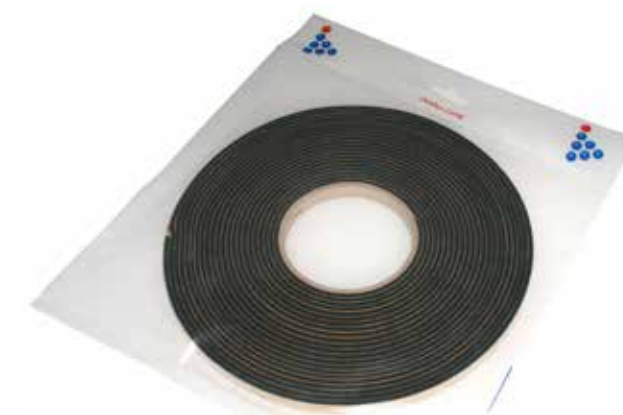

nr.	breedte mm	dikte mm	rollengte / role / rolle
7500902	9	2	200 meter
7501002	10	2	200 meter
7501502	15	2	160 meter
7502002	20	2	100 meter
7503002	30	2	60 meter

RUBBERVLOERBEDEKKING **RUBBER FLOORCOVER** **GUMMIBODENBELEG**



FIJN GERIBD
TREEPLANKRUBBER
RIBBED FOOTBOARD
FEIN GERIPPTES TRITTBET

nr.	dikte mm	rolafmeting
7300000	3	● 1,2m x 10m
7300000.1	3	● 1,0m x 10m

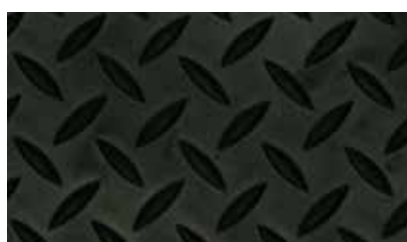

TRAANPLAATMOTIEF
DIAMONDRIB
DIAMANTTRIPPE

nr.	dikte mm	rolafmeting
7312000	3mm	1,5m x 10m
7312001	3mm	1,4m x 10m

oliebestendig /
oil resistant / ölbeständig



NOPPENMOTIEF
STUDDED PROFIL
NIETENPROFIL

nr.	dikte mm	rolafmeting
7311247	3	● 1,2m x 10m



RINGMATTEN
RINGMATS
RINGMATTEN

nr.	afmeting
7313004	● 100 x 75 cm
7313005	● 150 x 100 cm



VERBINDINGSSTUKKEN
CONNECTORS
ANSCHLUSS
(VOOR ONZE RINGMATTEN - FOR OUR RINGMATS - FÜR UNSERE RINGMATTEN)

nr.
7313333



RIJSTKORREL PROFIEL
GRAIN OF RICE PROFILE
REISKORNPRIEFIL

Profiel 3mm dik

nr.	dikte mm	rolafmeting
7300005	3	● 1,5m x 10m



KLEIN DIAMANT PROFIEL
SMALL DIAMOND PROFILE
KLEINES DIAMANT PROFIL

nr.	maat
7312002	1,2 mtr x 10 mtr ●



ANTISLIPMAT TYPE SAFE
NON-SLIP MAT AQUA-SAFE
RUTSCHFESTE MATTE
TYP AQUA-SAFE
ZELFKLEVEND - SELF-ADHESIVE - SELBSKLEBENDES

nr.	afmeting
71119010	● 119x1000 cm



ANTISLIP TAPE **ANTI RUTSCH-KLEBEBAND**
GLOW LINE

Niet giftig en vrij van fosfor of radioactief materiaal.

Non-toxic and free of phosphorus or radioactive material.

Ungiftig und frei von Phosphor oder radioaktivem Material.

nr.	rolafmeting
71119110	50 mm x 18 meter



PAKKINGSPLAAT SBR
GASKETPLAT SBR
PLATTENDICHTÜNGE SBR

Beide zijden glad / smooth / glatt

nr.	dikte mm
7314001	● diverse diktes met en zonder inlage op aanvraag various thickness with and without insert on request verschiedene Stärken mit und ohne Einsatz auf Anfrage
7315103	met 1 inlage 3mm



NEO BENZID

OLIE, BENZINE EN BIO-DIESEL BESTENDIG PAKKINGSPLAAT
OIL-GASOLINE AND BIO DIESEL RESISTANT GASKETPLATE
OL-BENZIN-UND BIODIESEL BESTANDIGE DICHTUNGSPLATTE

nr.	dikte mm	rolafmeting
7316003	3 ●	1,4m x 10m
7316005	5 ●	1,4m x 10m



ANTISLIPMAT ZELFKLEVEND
TRAANPLAAT MOTIEF MET AFGERONDE HOEKEN
NON-SLIP MAT SELF ADHESIVE
RUTSCHFESTE MATTE SELBKLEBENDES

nr.	afmeting
733332801.1	450 x 450 mm
733332802.1	150 x 450 mm
733332803.1	200 x 500 mm
733332804.1	200 x 650 mm
733332806.1	340 x 660 mm
733332807.1	160 x 600 mm
733332808.1	710 x 490 mm

PRIJZEN PER M²
PRICES PER M²
PREISE PRO M²

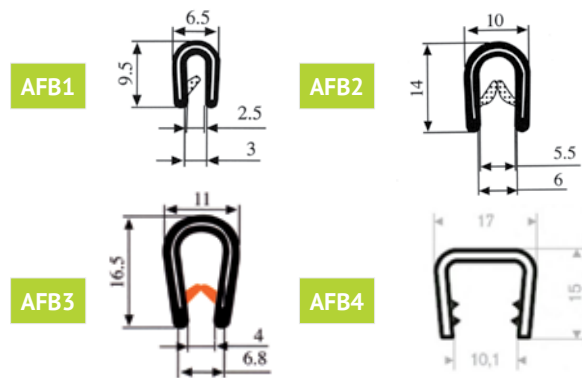

ZELFKLEMMEND U-PROFIEL KLEIN
PROFIL DESIGNED FOR TRIMMING
PROFIL ZUM UMSÄUMEN

nr.	klembereik		AFB	rollengte
2001013	1 - 3 mm	●	1	50 meter
2005025	2 - 5 mm	●	2	50 meter
2005125	2 - 5 mm	●	2	50 meter
2005068	6 - 8 mm	●	3	50 meter
2005012	10 -12 mm	●	4	50 meter

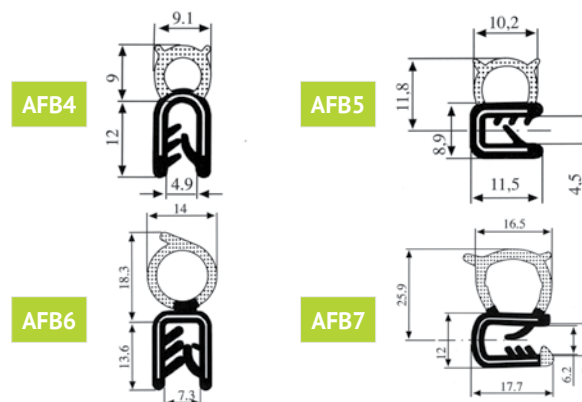

ZELFKLEMMEND U-PROFIEL
MET SPONS RUBBER
WITH WATERPROOF NEOPRANE FOAM SEAL
MIT DICHTFLIPPE AUS NEOPREN

nr.	positie	klembereik	AFB	rollengte
2119013	bovenkant	1 - 3 mm	●	4
2118013	zijkant	1 - 3 mm	●	5
2009025	bovenkant	2 - 5 mm	●	6
2008025	zijkant	2 - 5 mm	●	7

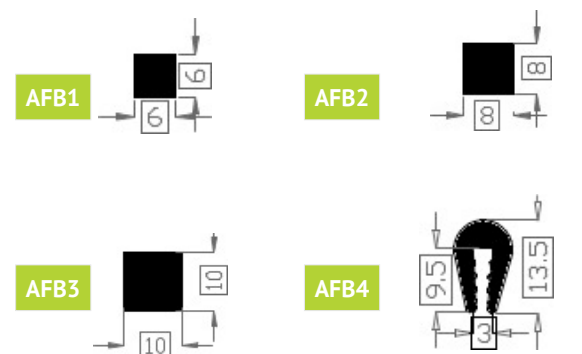

TPE PAKKING T.B.V. PATRIJSPOORTEN
SEAL FOR PORTHOLE
ABDICHTGUMMI FÜR BULLAUGE

nr.	maten		AFB	rollengte
1050606	6 x 6 mm	●	1	50 meter
2014011	8 x 8 mm	●	2	50 meter
2014012	10 x 10 mm	●	3	50 meter

73261209	Volrubber 1 - 3 mm	●	4	50 meter
	Profil designed for trimming			
	Profilleiste			



DUBBELZIJDIGE TAPE
DOUBLE SIDED TAPE
DOPPEL SEITIGES KLEBEBAND

Uitermate geschikt voor TPE profielen.
 Extremely suitable for TPE profiles
 Sehr gut geeignet für TPE profil

nr.	
85553	3 meter

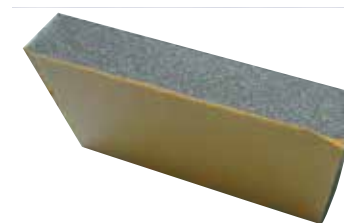

GELUIDSISOLATIEPLAAT
SOUNDISOLATIONBOARD
SCHALLSCHUTZPLATTE

nr.	
9500020	2000 mm x 1000 mm x 30 mm (lxbxh)



WATERZAK 20 LITER
POTABLE WATERBAG
TRINKWASSERSACK

nr.	omschrijving
155520	Oprolbaar, als rugzak te dragen can be rolled up, can be worn as a backpack kann aufgerollt und als rucksack getragen werden



O-RING BOX
METRISCH - METRIC - METRIK

O-Ring box H NBR 70 Shore

nr.	
40917	30 maten / sizes / grosses 404 stuks / pieces / stuck



STROOMLIJNFLAP
STREAMLINE RUBBER
GUMMI ABDECKPLATTE

nr.	
DGR-117	



BRANDSTOFZAK 20 LITER
FUELBAG EASY TO CARRY
TANKBEUTEL

nr.	omschrijving
155521	Oprolbaar, als rugzak te dragen can be rolled up, can be worn as a backpack kann aufgerollt und als rucksack getragen werden



O-RING BOX
INCH - INCH - ZOLL

O-Ring box G NBR 70 Shore

nr.	
34823	30 maten / sizes / grosses 382 stuks / pieces / stuck



nr.			
DGR-01	A	Rubber bocht groot Rubber bend large Gummibiegung groß	
DGR-02	B	3-weg vormstuk 3 way molding 3 wege formteill	
DGR-03	C	Thermostaat bocht Thermostat bend Thermostatboge	



RONDSNOER SERVICE KIT
ROUND CORD SERVICE KIT
RUNDKABEL SERVICE KIT

Maak u eigen afdichtingsring
 Make your own o-ring
 Mach deinen eigenen o-ring

nr.	
57248	1,8 tot/upto/bis 8mm lengtes/lengths/longe 2m



DEMONTAGE SET 4-DELIG
DISASSEMBLY SET 4 PCS
DEMONTAGESATZ 4 STK

Demontage set voor o-ringen + u manchetten

nr.	
502438	

STOOTRANDEN - RUBBING STROKES - SCHEUERLEISTE



De radial PVC stootranden zijn de nieuwe ontwikkeling op (kunststof/PVC) stootranden gebied. Deze PVC stootrand hoeft niet meer verwarmt te worden in een bak warm water, maar kan koud worden gemonteerd nadat de basislijst op het te beschermen object (boot) is bevestigd.

Invisible rigid base designed to be placed on the hull, the external profile with easy pressure installation.

Nicht sichtbare steife Grundschiene, die an das Boot angeschraubt wird, die auBeres Profil das einfach durch druck montiert wird.



**PVC STOOTRANDEN INCLUSIEF ONDERLIJST
RUBBINGSTROKE DELIVERED COMPLETE
LIEFERUNG SCHEUERLEISTE GANZ COMPLET**

**RVS EINDKAPPEN
STAINLESS STEEL ENDPIECE
EDELSTAHL EINDSTÜCK**

nr.	maten	gewicht g/m	rollengte
13014005	Radial 30 mm	541	24 meter
13014010	Radial 40 mm	855	24 meter
13014015	Radial 52 mm	1550	24 meter
13014020	Radial 65 mm	1610	24 meter
13014025	Radial 80 mm	1915	24 meter

Op verzoek leverbaar in afwijkende rollengte, maar altijd gebaseerd op 2 meter onderlijst

nr.	voor / for / für	
13114009	radial 30 mm	per stuk
13114011	radial 40 mm	per stuk
13114015	radial 52 mm	per stuk
13114022	radial 65 mm	per stuk

TECHNISCHE TEKENINGEN RADIAL

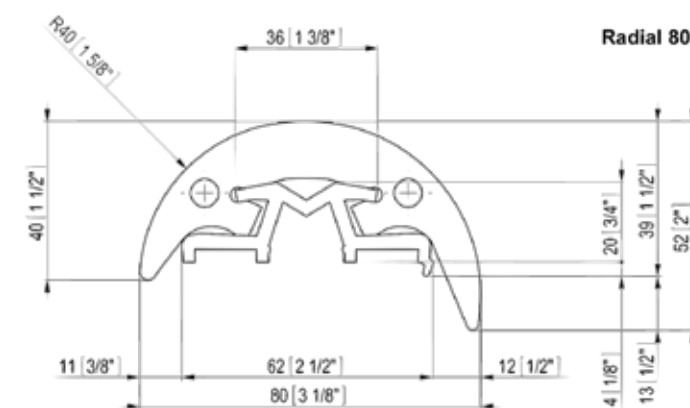
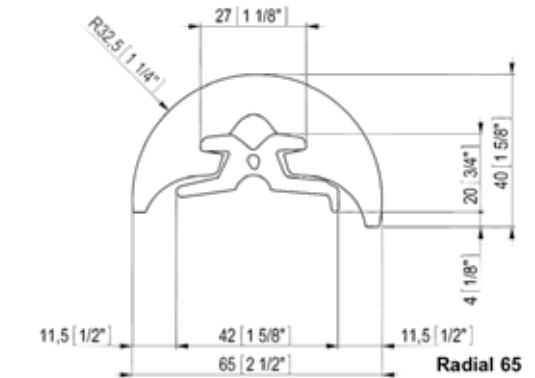
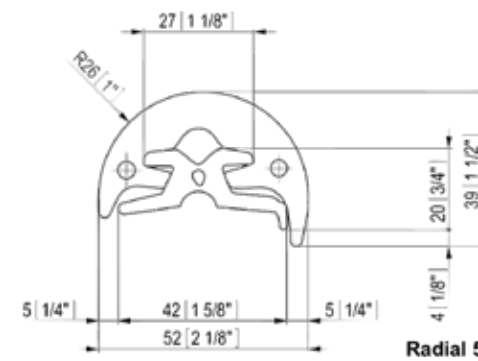
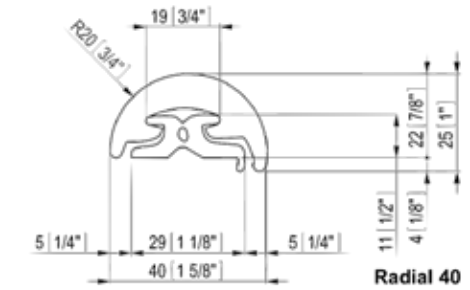
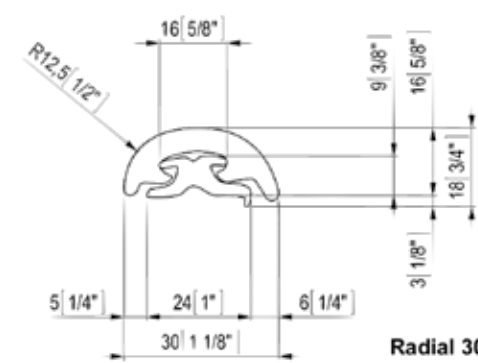

BINO



KLEUR / COLOR / FARBE:



BINO STOOTRAND
BINO TENDERPROFILE
BINO PROFILLEIESTE

nr.	maten	rollengte
130-115-001	Bino stootrand 40 x 23	24 meter
130-115-005	Bino stootrand 65 x 37	24 meter
130-115-010	Bino stootrand 90 x 53	24 meter

TECHNISCHE TEKENINGEN BINO

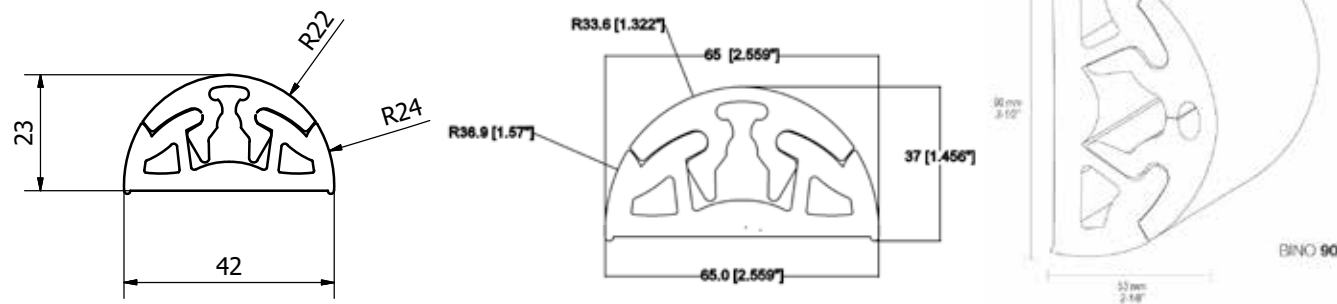

BINOX



BINOX STOOTRAND BASIS
BINOX TENDERPROFILE BASE
BINOX SCHEUERLEIESTE

nr.		vpe
130-230-040	BinoX 25mm ●	24 mtr
130-230-050	BinoX 35 mm ●	24 mtr
130-230-070	BinoX 50 mm ●	24 mtr
130-230-090	BinoX 65 mm ●	24 mtr

BINOX INSERT RVS
BINOX S/SBAR
BINOX PROFILLEIESTE

nr.		vpe
130-230-125	BinoX 25 mm	24 mtr
130-230-135	BinoX 35 mm	24 mtr
130-230-150	BinoX 50 mm	24 mtr
130-230-165	BinoX 65 mm	24 mtr

RVS EINDKAP BINOX
STAINLESS STEEL ENDPIECE BINOX
EDELSTAHL EINDSTÜCK BINOX

nr.	
130-500-425	tbv BinoX 25 mm (set)
130-500-435	tbv BinoX 35 mm (set)
130-500-450	tbv BinoX 50 mm (set)
130-500-465	tbv BinoX 65 mm (set)



Projected and designed
by **Tessilmare - ITALY**

SPHAERA



RVS STRIP TENDERPROFILE PROFILLEISTE

nr.	maten	gewicht	lengte
130-130-125	25mm	470 g/m	2 meter
130-130-135	35mm	830 g/m	2 meter
130-130-150	50mm	1200 g/m	2 meter
130-130-165	65mm	1535 g/m	2 meter

PVC ONDERLIJST PVC BASE PVC SCHEUERLEISTE

Rollengte 24 meter, kleur: wit



nr.	maten	rollengte	lengte
130-130-041	25mm	356 g/m	24 meter
130-130-051	35mm	646 g/m	24 meter
130-130-071	50mm	1400 g/m	24 meter
130-130-091	65mm	1635 g/m	24 meter

BASE SLIM

nr.	gewicht g/m	voor sphaera		lengte rol
130-130-039/Z	125	25	●	24 meter
130-130-039/W	125	25	○	24 meter
130-130-049/Z	135	35	●	24 meter
130-130-049/W	135	35	○	24 meter
130-130-069/Z	183	50	●	24 meter
130-130-069/W	183	50	○	24 meter
130-130-089/Z	425	65	●	24 meter
130-130-089/W	425	65	○	24 meter



EINDKAP BASE SLIM ENDCAP EINDSTUCK

nr.	maten	eenheid
130-500-625	25mm	per stuk
130-500-635	35mm	per stuk
130-500-650	50mm	per stuk
130-500-665	65mm	per stuk



DOORVERBINDEN TOPCAP ABSTECKPROFIL

nr.	maten	eenheid
130-500-125	25mm	per stuk
130-500-135	35mm	per stuk
130-500-150	50mm	per stuk
130-500-165	65mm	per stuk



EINDKAP PVC BASE ENDCAP EINDSTUCK

nr.	maten	eenheid
130-500-725	25mm	2 stuks
130-500-735	35mm	2 stuks
130-500-750	50mm	2 stuks
130-500-765	65mm	2 stuks

TECHNISCHE TEKENINGEN

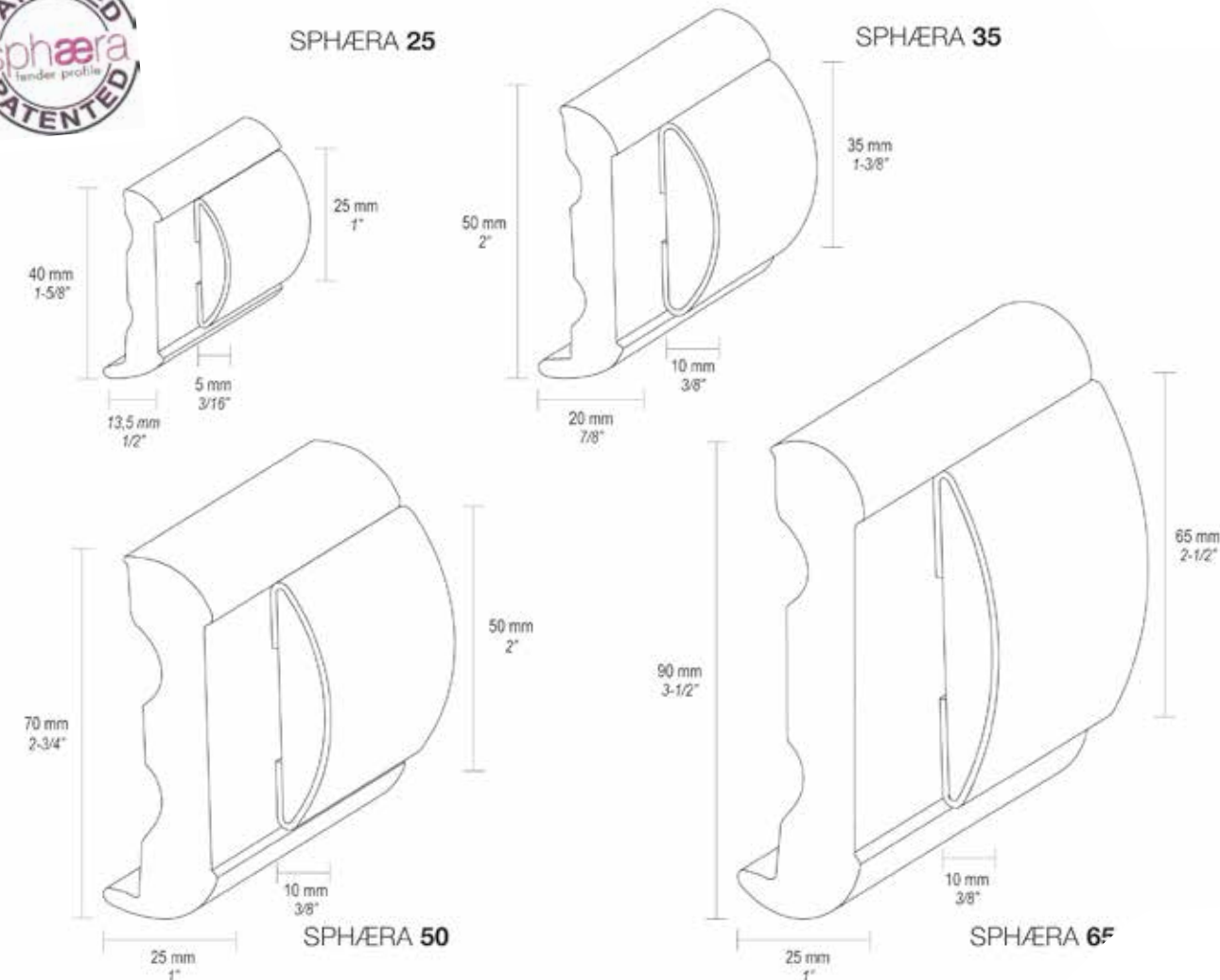



**SLANGEN
HOSES
SCHLAUCHEN**



**DIESELUITLAATSLANG
IN DE GEGOLFDE UITVOERING
HOSE FOR EXHAUSTSYSTEM
AUSPUFFSCHLAUCH MIT LLOYD'SABNAHME**

Rubber diesel uitlaatslang met stalen spiraal.

Voor watergekoelde dieselmotoren.

Temp.bereik: -30 °C tot +100 °C

Soepel, dus makkelijk te monteren LLOYDS en RINA gekeurd volgens Iso 13363 Certificaten zijn op aanvraag leverbaar

Let op: 5 jaar garantie!

Made of rubber type-approved by Rina and Lloyd the hoses are fitted with a black smoothrubber, high resistant synthetic fabric and built in metal spirals. Resistant to Oil-products, Salt water, atmospheric and abrasion.

Temp reache: -30 C up to 100 C

Warranty: 5 years. Certificats on request

Sehr flexibel Gummi schlauch mit stahlerenSpirale

Mit Rina und Lloyd Zulassung

Bestendig zum Erdolprodukten, Seewasser und Klimateinflusse

Temp.reiche: -30 C bis zum 100 C

Garantie: 5 jahre. Zertifikat am anfrage

nr.	Ø / Q	rollengte / role / rolle
3735020	20/28	20
3735025	25/33	20
3735032	32/40	20
3735038	38/46	20
3735040	40/49	20
3735045	45/54	20
3735051	51/60	20
3735060	60/70	20
3735065	65/74	20
3735076	76/86	20
3735080	80/90	20
3735090	90/100	20
3735102	102/113	20
3735110	110/121	20
3735127	127/137	20
3735150	150/163	20
3735203	203/219	10
3735305	305/325	op aanvraag / on request auf Anfrage



**BRANDSTOFLANG ISO 7840 A1
BLACK SMOOTH SYNTHETIC RUBBER
WITH TEXTILES PILAR
GLATTER TREIBSTOFFSCHLAUCH MIT
AUFDRUCK**

Gladde uitvoering CE gekeurd

Temp.bereik: -20°C tot +80°C



nr.	Ø / Q	werkdruk bar working pressure Arbeitsdruck	rollengte/role/rolle
3330006	6/16	3	40
3330008	8/17	3	40
3330010	10/19	3	40
3330125	12,5/22	3	40
3330016	16/26	3	40
3330019	19/30	3	40
3330025	25/35	3	40



**BRANDSTOFLANG ISO 7840 A1
FUELHOSE WITH METALSPIRAL
GUMMI KRAFTSTOFFSCHLAUCH MIT
STÜHLERNER SPIRALE**

Met doekafdruk en Stalen spiraal CE gekeurd

Temp.bereik: -20°C tot +80°C



nr.	Ø / Q	werkdruk bar working pressure Arbeitsdruck	rollengte / role / rolle
3330032	32/42	3	20
3330038	38/48	3	20
3330050	51/61	3	20



BLADZIJDE / PAGE / ZEITE 78

100 R4 SAE J 517

**OLIE EN KOELWATERSLANG
OIL AND COOLING WATER HOSE
ÖL UND KÜHLWASSERSCHLAUCH**

Olie- en benzine bestendige zuigpersslang met stalen spiraal en "static-wire". Te gebruiken als vulslang of koelwaterslang.

Zeer soepele uitvoering.

Oil- and petrolresistant (suction/discharge)hose with metallic spiral "static wire" to be used as a fillinghose or coolingwater-hose. Very smooth execution

Ol- und Benzin bestandige Saug/Pressschlauch mit stahleren spirale und "statischer draht"

Als Fullschlauch oder Kuhlwasserschlauch zu verwenden. Sehr reibungslose Ausfuehrung

Vacuüm: 0,8 bar

Temp.bereik: -30 °C tot +100 °C

nr.	Ø / Q	werkdruk bar working pressure Arbeitsdruck	rollengte/role/rolle
3350013	13/23	21	20
3350016	16/26	21	20
3350019	19/29	21	20
3350025	25/36	17	20
3350032	32/43	14	20
3350035	35/47	12	20
3350038	38/49	10	20
3350042	42/55	10	20
3350045	45/58	8	20
3350050	50/63	7	20
3350060	60/74	5	20

**KOELWATER-/HEETWATERSLANG 'CARHEATER'
COOLING / HOT WATER HOSE
KÜHLWASSER/ HEISSWASSERSCHLAUCH**

Temp.bereik: -40°C tot +120°C

Bestand tegen gebruikelijke antivriesmiddelen en koelvloeistof

Resistant to the usual antifreeze and coolant

Beständig gegen des übliche Frostschutzmittel und Kühlmittel

nr.	Ø / Q	werkdruk bar working pressure Arbeitsdruck	rollengte/role/rolle
3120013	13/20	10	40
3120016	16/23	10	40
3120019	19/27	10	40

HOT WATER + 120°C

**HOT WATER SLANG
HOT WATER HOSE
HEISSWASSERSCHLAUCH**

Zeer soepele EPDM rubberen zuigpersslang voor warm- en zeewater. Met stalen spiraal.

Hot waterhose of special saltwater and heat resistant rubber.

Aus speziellem meerwasser- und hitzebeständig Gummi.

Temp.bereik: -40°C tot 120°C

nr.	Ø / Q	werkdruk bar working pressure Arbeitsdruck	rollengte/role/rolle
3351016	16/26	10	20
3351020	19/29	10	20
3351025	25/35	10	20
3351032	32/43	10	20
3351038	38/49	10	20
3351050	51/63	10	20
3351063	63,5	10	20

MERCUR 20 FUEL / OIL 25 X 35 MM WP/BP

MERCUR FUEL EN OIL

Olie en benzine bestendige rubberslang.

Smooth hose for fuel

Gummi Kraftstoffschlauch

Barstdruk: 30 bar

Inwendig: nitrile rubber

Uitwendig: EPDM

Temp.bereik: -35°C tot +90°C

nr.	Ø / Q	werkdruk bar working pressure Arbeitsdruck	rollengte/role/rolle
3320006	6/13	20	50 meter
3320008	8/15	20	50 meter
3320010	10/17	20	50 meter
3320013	13/20	20	50 meter
3320016	15/23	20	50 meter
3320019	19/27	20	50 meter
3320025	25/35	20	50 meter



GEURDICHTE SANITARY SLANG
ANTI ODOR SANITATION HOSE
GERUCHDICHTHEITSSCHLAUCH

MET 10 JAAR GARANTIE EN STALEN SPIRAAL
WITH 10-YEAR WARRANTY - MIT 10 JAHRE GARANTIE

nr.	Ø / Q	werkdruk bar working pressure Arbeitsdruck	rollengte/role/rolle
4494016	16/26	7	30,5
4494019	19/29	7	30,5
4494025	25/35	7	30,5
4494038	38/48	7	30,5



FITT DIAMOND SANITAIRSLANG
SPIRAL REINFORCED HOSE
SANITARSCHLAUCH METALLFREI

10 jaar garantie productie, kwaliteit en geurdicht.
 Metaalvrij en soepele slang

nr.	Ø / Q	werkdruk bar working pressure Arbeitsdruck	rollengte/role/rolle
4493020	20/27.4	3	20
4493025	25/34	3	20
4493038	38/50	3	20
4493050	50/62	3	20



SANITAIRSLANG ●

nr.	Ø / Q	werkdruk bar working pressure Arbeitsdruck	rollengte/role/rolle
4491016	16/22.6	8	30
4491020	20/26	8	30



PVC ZUIG/PERSSLANG MET STALEN SPIRAAL
TRADITIONAL SPIRAL HOSE
SAUCH/PRESS SCHLAUCH MIT STÄHLERNER SPIRAL

Temp.bereik: - 15 °C tot + 60 °.

nr.	Ø / Q	werkdruk bar working pressure Arbeitsdruck	rollengte/role/rolle
4480010	10/16	7	30
4480013	13/19	7	30
4480016	16/22	6	30
4480019	20/27	5	30
4480025	25/33	5	30
4480032	32/40	4,5	30
4480035	35/43	4	30
4480038	38/47	4	30
4480040	40/50	3	30
4480045	45/55	3	30
4480050	50/62	3	30



SANIFLEX MET STALEN SPIRAAL
SANIFLEX WITH STEEL SPIRAL INLAY
TOILETTENSCHLAUCH MIT STÄHLERNER SPIRAL

Niet geschikt voor gebruik met vuilwatertank
Not for use in combination with wastewater tank
Nicht zur Verwendung mit Abwassertank

nr.	Ø / Q	rollengte/role/rolle
4490016	16/21	30
4490020	19/26	30
4490025	25/33	30
4490032	32/40	30
4490038	38/46	30



BOILERSLANG

DRINK- EN BOILERSLANG, BESTAND TEGEN KOELVLOEISTOF
HOTWATERHOSE FOR BOILER, RESISTANT FOR COOLANT
DAMPFEN/HEISSWASSER SCHLAUCH, BESTÄNDIG GEGEN KÜHLMITTEL

Temp.bereik: -40 °C - +120 °C
 Binnenwand: EPDM
 Buitenwand: EPDM
 Kleur: Stip met blauw

nr.	Ø / Q	rollengte/role/rolle
3472013	13/23	variabel
3472016	16/26	variabel
3472019	19/31	variabel



FITT NTS YELLOW

PVC WATERSLANG
PVC WATERHOSE
PVC WASSERSCHLAUCH

Temp.bereik: - 10 °C tot + 40 °C
 Barstdruk: 25 bar
 Binnenwand: wit glad
 Buitenwand: ●
 Werkdruk bij 25°C: 10 bar

nr.	Ø / Q	rollengte/role/rolle
41000125	12,5/17,5	50 meter
41000125/25	12,5/17,5	25 meter
4100019	19/25,5	50 meter
4100025	25/33	50 meter
4100032	32/40	50 meter
4100038	38/46	25 meter



DELPHINUS

PVC AFZUIGSLANG
PVC SUCTION AND VENTILATION HOSE
KUNSTOFF ABSAUG UND BELÜFTUNGSSCHLAUCH MIT PVC SPIRALE

Temp.bereik: -10 °C - +60 °C

nr.	Ø / Q	rollengte/role/rolle
4500020	20/25	50 meter
4500025	25/30	50 meter
4500028	28/33	20 meter
4500030	30/36	50 meter
4500032	32/38	50 meter
4500035	35/41	50 meter
4500038	38/45	50 meter
4500050	50/57	50 meter



AQUAFOOD

DRINKWATERSLANG
DRINKINGWATERHOSE
TRINKWASSERSCHLAUCH

Temp.bereik: tot + 60°C
 Binnenwand: blank transparant, glad
 Rollengte: 50 meter

nr.	Ø / Q	rollengte/role/rolle
3470013	12.3/20	●
8300013	12.3/20	●



PVC-TRANSPARANT

Temp -20°C tot +60°C
 Transparante niet-versterkte slang voor veelzijdig gebruik. Levensmiddelenkwaliteit.
 Transparant, non-reinforced PVC hose for general applications. Food quality.
 Transparanter, nicht verstaerchter Kunststoff-Wasserschlauch für vielseitigen Gebrauch, in Lebensmittelqualität.

nr.	Ø / Q	rollengte/role/rolle
4041006	6/9	100 meter
4041008	8/12	50 meter
4041010	10/14	50 meter
4041012	12/16	50 meter
4041015	15/20	50 meter
4041019	19/25	50 meter
4041025	25/31	50 meter



AIRCO SLANG
AIRCOHOSE
AIRCOSLAUCH

Speciale kunststof slang geschikt voor de transport van lucht, gas, rook, vermindering van condensatie en geen verlies van warmte. Bij installeren let op de juiste blaasrichting. Anti-schimmel en anti-bacterie.

Special plastic hose with spiral suitable for transporting air, gas, smoke, reducing condensation and no loss of heat. When installing, pay attention to the correct blowing direction. Anti-fungal and anti-bacteria.

Spezialplastikschlauch mit Spirale zum Transport von Luft, Gas, Rauch, zur Reduzierung von Kondensation und ohne Wärmeverlust. Achten Sie bei der Installation auf die richtige Blasrichtung. Anti-Pilz und Anti-Bakterien.

Temp: -40 °C - +100 °C.

datasheet: www.dgrubberholland.nl

nr.	Ø	rollengte/role/rolle
8400055	55	10
8400060	60	10
8400075	75	10
8400080	80	10
8400090	90	10
8400102	102	10
8400127	127	10
8400152	152	10
8400180	180	10
8400203	203	10
8400254	254	10



PARALLAX

VERWARMINGS/AFZUIGSLANG
SINGEL WALL RUBBER SUCTION AND VENTILATION HOSE
EINWANDIGE GUMMI ABSAUG-UND FORDERSCHLAUCH

Temp: -35 °C tot +135°C.

Enkelwandige zeer soepele zelfdovende afzuigslang, voor transport van lucht met een hoog eigen- en/of omgevingstemperatuur (kortstondig 150 graden celcius)

Very smooth self-extinguishing suction hose for transport of air and gasses with high ambient temperatures. Single wall

Hochflexibler selbstloschender Absaug Schlauch zum Durchleiten von Luft und gasförmigen Medien mit hoher Eigen- oder Umgebungstemperatur. Einlagenschlauch

nr.	W.D. bar	Ø	Vacuum %	rollengte/role/rolle
8505060	1.1	60	40	4 meter
8505076	1.1	76	34	4 meter
8505080	1	80	32	4 meter
8505089	1	90	30	4 meter
8505102	1	102	26	4 meter

L.D.A

LASDAMP AFZUIGSLANG
WELDING FUME EXTRACTION
SCHWEISSRAUCH ABSAUGUNG



Grijs vinyl gecoat synthetisch weefsel met vinyl ommantelde stalen spiraal.

Gray vinyl-coated synthetic fabric with vinyl coated steel spiral.

Graues vinylbeschichteter synthetisches Gewebe mit vinylbeschichteter Stahlschnecke.

Temp. -10°C tot +180°C volgens brandklasse 1

nr.	Ø	rollengte/role/rolle
4535076	76	6 meter
4535127	127	12 meter
4535152	152	10 meter
4535180	180	8 meter



PVC COMPRESSOR SLANG
PLASTIC COMPRESSOR HOSE
KUNSTSTOFF-KOMPRESSORSCHLAUCH

Met polyester inlagen en lengtedraad. De luchtcompressor-slang bij uitstek. Door de toepassing van zeer hoogwaardige grondstoffen is deze slang zeer soepel en multifunctioneel. Temp. bereik: -20 °C tot +60 °C

Constructie: polyester inlagen, in- en uitwendig, glad met opdruk

Suitable for compressed air, water and mild chemicals
Geeignet Pressluft, Wasser und leichte Chemikalien

nr.	Ø / Ø	werkdruk	rollengte/role/rolle
4200006	6/12	20	50 meter
4200008	8/14	20	50 meter
4200010	10/16	20	50 meter
4200013	13/19	12	50 meter
4200016	16/22	10	50 meter
4200019	19/26	10	50 meter
4200025	25/33	8	50 meter
4200032	32/42	7	25 meter
4200038	38/48	6	25 meter
4200050	50/60	5	25 meter



BELINDA - AIR

W.D bar 20

Temp: -20°C tot +80°C

Rubber perslucht slang geschikt voor perslucht, water en niet agressieve producten.

Suitable for compressed air, water and non-aggressive products.

Gummi-Druckluftschlauch geeignet für Pressluft, Wasser und nicht-aggressive Produkte

nr.	Ø / Ø	rollengte/role/rolle
3200006	6/13	50 meter
3200008	8/15	50 meter
3200010	10/18	50 meter
3200013	13/21	50 meter
3200019	19/29	50 meter



RADIATEURSLANG
RADIATORHOSE
KÜHLERSCHLAUCH

Bestand tegen de gebruikelijke antivries middelen.

Resistant to the usual antifreeze.

Beständig gegen des übliche Frostschutzmittel.

Binnenwand: zwart glad

Buitenwand: zwart met doekafdruk

Temp. bereik: -40°C tot +120°C

Opdruk: DIN 73411, inw. diam. x wanddikte

nr.	Ø / Ø	werkdruk bar working pressure Arbeitsdruck	lengte
3117022	22/29	4	1 meter
3117025	25/32	4	1 meter
3117028	28/36	4	1 meter
3117030	30/38	4	1 meter
3117032	32/40	4	1 meter
3117035	35/43	4	1 meter
3117038	38/48	4	1 meter
3117040	40/50	4	1 meter
3117042	42/52	4	1 meter
3117045	45/55	4	1 meter
3117048	48/58	4	1 meter
3117050	50/60	4	1 meter
3117055	55/65	4	1 meter
3117060	60/70	4	1 meter
3117075	76/86	4	1 meter

FITT-IKON

Gewicht besparende Flexibele slang

Ultra light Extentable hose

Ultra lighte Flexi schlauch

Bedrijfsdruk: 1>4 bar

Werktemp: -10>+50 C

Bestand tegen UV-straling



nr.	rollengte/role/rolle
215882	25 meter



HAND HEVELPOMP
MANUAL SIPHON PUMP
MANUELLE SIPHONPUMP

nr.	
166611419	Blister verpakking



EPDM DEKWASLANG
ANTISTATISCH - ANTI-STATIC
Temp.bereik: - 40 °C tot + 110 °C

nr.	Ø / Q	rollengte/role/rolle
4440013	13/20	40 meter
4440019	19/27	40 meter
4440025	25/34	40 meter
4440032	32/44	40 meter
4440038	38/50	40 meter



SLANGLOSSER
HOSE UNLOADER
SCHLAUCHENTLADER

nr.		
4400001	A	haaks/angled/ abgewinkelt
4400002	B	recht/straight/Gerade



BRANDSTOFSLANG
MET METAALOMVLECHTING
OIL OR GASOLINE HOSE
WITH STEEL BRAIDED COVER
OL-UND BENZINBESTANDIGE GUMMISCHLAUCH
STAHLDRAHT UMFLUCHTEN MIT EINLAGEN

Temp.: -20°C tot +90°C

nr.	Ø / Q	bar	rollengte/role/rolle
3340006	6/11	25	25 meter
3340008	8/13	25	25 meter
3340010	10/15	25	25 meter
3340013	13/18	25	25 meter
3340016	16/21	25	25 meter



GEPERSTE GASLANGEN **GASINSTALLATION HOSES** **GASANLAGEN SLAUCHEN**



glad / smooth / glatt

nr.	soort
991666001	verl.slang 60 cm 8mm knel x 8mm
991666002	verl.slang 80 cm 8mm knel x 8mm
991666016	verl.slang 100 cm 8mm knel x 8mm



glad / smooth / glatt

nr.	soort
991666004	verl.slang 60 cm 1/4 li.wartel x 8mm
991666005	verl.slang 80 cm 1/4 li.wartel x 8mm
991666006	verl.slang 100 cm 1/4 li.wartel x 8mm



nr.	soort
991666007	verl.slang 60 cm 1/4 li.wartel x 8mm knel
991666008	verl.slang 80 cm 1/4 li.wartel x 8mm knel
991666009	verl.slang 100 cm 1/4 li.wartel x 8mm knel



nr.	soort
991666010	verl.slang 60 cm 2x 1/4 li.wartel
991666011	verl.slang 80 cm 2x 1/4 li.wartel
991666012	verl.slang 100 cm 2x 1/4 li.wartel



nr.	soort
991666013	verl.slang 60 cm 2 x 8 mm knel
991666014	verl.slang 80 cm 2 x 8 mm knel
991666015	verl.slang 100 cm 2 x 8 mm knel



nr.	soort
991666032	verl.slang 60 cm 2 x 8 mm
991666035	verl.slang 80 cm 2 x 8 mm
991666022	verl.slang 100 cm 2 x 8 mm

PROPAANGASSLANG
GASINSTALLATION HOSE
GASANLAGEN SLAUCH

NEN-EN 16436-1

nr.	inw./uitw.	rollengte
3265008.2	8/15	50 meter

CLASS 2-8 MM-10 BAR-PROPANE/BUTANE



**KLEMMEN
HOSE CLAMPS
SCHLAUCHSCHELLEN**



MINIKLEMMEN
GEGALVANISEERD - GALVANIZED
VERZINKT

nr.	formaat	vpe
6005008	8	50
6005009	9	50
6005010	10	50
6005011	11	50
6005012	12	50
6005013	13	50
6005014	14	50
6005015	15	50
6005016	16	50
6005017	17	50



MINIKLEMMEN
RVS - STAINLESS STEEL - NIRO

nr.	formaat	vpe
6026008	8	50
6026009	9	50
6026010	10	50
6026011	11	50
6026012	12	50
6026013	13	50
6026014	14	50
6026015	15	50
6026016	16	50



WORMSCHROEFKLEMMEN
HOSE CLAMPS
SCHRAUBSCHLAUCH-
KLEMMEN

RVS - STAINLESS STEEL - NIRO

Let op: W5 kwaliteit

Volledig roestvrijstalen W5 slangklemmen. Roestvrijstalen band W5 (AISI 316). Roestvrijstalen huis W5 (AISI 316). Roestvrijstalen schroef W5 (AISI 316). Conform DIN 3017 en SMS 2298

nr.	Ø / Ø	vpe
6011008	8/16	50
6011013	12/20	50
6011015	16/27	50
6011019	20/32	50
6011026	25/40	50
6011032	30/45	50
6011038	32/50	50
6011044	40/60	50
6011050	50/70	50
6011058	60/80	Los
6011068	70/90	Los
6011077	80/100	Los
6011087	90/110	Los



EINDKAP WORMSCHROEFKLEM
END CAP HOSE CLAMPS
EINSTÜCK SCHAUBSLAUCH-
KLEMMEN

nr.		e.h.
6012000	12 mm	200
6012001	9 mm	200



WORMSCHROEFKLEMMEN
HOSE CLAMPS
SCHRAUBSCHLAUCH-
KLEMMEN

GEGALVANISEERD - GALVANIZED
VERZINKT

Conform DIN 3017 en SMS 2298; schroef met zeskant. Band met gesloten fraising en voorzien van afgeronde kanten, zodat beschadiging van de slang wordt voorkomen. Gegalvaniseerd en gechromatiseerd. Voldoet aan de strengste eisen.

nr.	Ø / Ø	vpe
6000008	8/14	50
6000011	11/17	50
6000013	13/20	50
6000015	15/25	50
6000019	19/32	50
6000026	26/40	50
6000032	32/44	50
6000038	38/50	50
6000044	44/60	50
6000050	50/70	50
6000058	58/80	Los
6000068	68/90	Los
6000077	77/100	Los
6000087	87/110	Los



LEIDINGKLEMMEN
CABLE / PIPE HOLDERS
SCHLAUCH-ROHRSCHELLEN

RVS - STAINLESS STEEL - NIRO

Roestvrijstalen band W4 (AISI) Voorzien van EPDM rubber. Bandbreedte: 12 mm

nr.	klembereik	vpe
6051006	6	100
6051008	8	100
6051010	10	50
6051013	13	50
6051016	16	50
6051021	21	50
6051029	29	50
6051035	35	50
6051045	45	50
6051051	51	50



LEIDINGKLEMMEN
CABLE / PIPE HOLDERS
SCHLAUCH-ROHRSCHELLEN

GEGALVANISEERD - GALVANIZED

VERZINKT

Voorzien van EPDM rubber.

Bandbreedte: 12 mm (conform DIN 3016)

nr.	klembereik	vpe
6054006	6	100
6054008	8	100
6054010	10	50
6054013	13	50
6054016	16	50
6054021	21	50
6054026	26	50
6054029	29	50
6054035	35	50
6054051	51	50



SUPERSTRENGHT KLEM
SUPERSTRENGHT CLAMP
SUPERSTARKE KLEMME

1- DELIG GEGALVANISEERD

GALVANIZED - VERZINKT

Eéndelige zware slangklemmen, voorzien van een M8 bout.

Materiaal: gegalvaniseerd volgens DIN 50941

Staalbanddikte: 1,5 mm

nr.	Ø / Ø	staalbandbreedte	
6200040	40/43	M8	20
6200044	44/47	M8	20
6200048	48/51	M8	20
6200052	52/55	M8	20
6200056	56/59	M8	20
6200060	60/63	M8	25
6200064	64/67	M8	25
6200068	68/73	M8	25
6200074	74/79	M8	25
6200080	80/85	M8	25
6200086	86/91	M8	25
6200092	92/97	M8	25
6200098	98/103	M8	25
6200104	104/112	M8	25
6200113	113/121	M8	25
6200122	122/130	M8	25
6200131	131/139	M8	25
6200140	140/148	M8	25
6200149	149/161	M8	25
6200162	162/174	M8	25
6200175	175/187	M8	25
6200188	188/200	M8	25
6200201	201/213	M8	25
6200214	214/226	M8	25
6200227	227/234	M8	25
6200240	240/252	M8	25
6200265	265/286	M8	25
6200270	270/280	M8	25
6200325	325/350	M8	25



SUPERSTRENGHT KLEM
SUPERSTRENGHT CLAMP
SUPERSTARKE KLEMME

1- DELIG RVS W5 KWALITEIT

STAINLESS STEEL - NIRO

Eéndelige zware slangklemmen, voorzien van een M8 / M6 bout.

Materiaal band: RVS AISI 316, Bout: M8 A4, Moer: M8 A4 / M6 A4

Staalbanddikte: 1,5 mm

nr.	Ø / Ø	staalbandbreedte	
6400026	26/28	M6	20
6400029	29/31	M6	20
6400032	32/35	M6	20
6400036	36/39	M6	20
6400040	40/43	M6	20
6400044	44/47	M6	20
6400048	48/51	M8	20
6400052	52/55	M8	20
6400056	56/59	M8	20
6400060	60/63	M8	25
6400063	64/67	M8	25
6400067	68/73	M8	25
6400074	74/79	M8	25
6400080	80/85	M8	25
6400086	86/91	M8	25
6400092	92/97	M8	25
6400095	98/103	M8	25
6400104	104/112	M8	25
6400110	113/121	M8	25
6400122	122/130	M8	25
6400132	131/139	M8	25
6400142	140/148	M8	25
6400152	149/161	M8	25
6400162	162/174	M8	25



ENKELE OORKLEM
SINGLE EARCLIP
EINZEHNE OHRCLIP

Deze enkele oorklem is aan de binnenkant glad en gemaakt uit band met W4 kwaliteit. Voor snelle en eenvoudige montage met behulp van tang 603000

This single earclip is smooth on the inside and made of W4 quality band for quick and easy mounting using pliers 603000

Dieser einzehe Ohrclip ist innen glatt und aus W4 Qualitätsband hergestellt. Für ein schnelle und eifage Montage mit der Zange 603000

nr.	Ø / Ø	staalbandbreedte	nr.	Ø / Ø	staalbandbreedte
6034060	6/7	M5 0,5	6034148	14,8/18	M7 0,6
6034070	7/8,7	M5 0,5	6034150	15/17,5	M7 0,6
6034073	7,3/9	M5 0,5	6034153	15,3/18,5	M7 0,6
6034078	7,8/9,5	M5 0,5	6034160	16/19,2	M7 0,6
6034083	8,3/10	M5 0,5	6034166	16,6/19,8	M7 0,6
6034088	8,8/10,5	M5 0,5	6034178	17,8/21	M7 0,6
6034092	9,2/10,9	M5 0,5	6034194	19,4/22,6	M7 0,6
6034094	9,4/11,9	M7 0,6	6034203	20,3/23,5	M7 0,6
6034096	9,6/11,3	M7 0,6	6034209	20,9/24,1	M7 0,6
6034098	9,8/12,3	M7 0,6	6034224	22,4/25,6	M7 0,6
6034103	10,3/12,8	M7 0,6	6034239	23,9/27,1	M7 0,6
6034108	10,8/13,3	M7 0,6	6034254	25,4/28,6	M7 0,6
6034113	11,3/13,8	M7 0,6	6034269	26,9/30,1	M7 0,6
6034115	11,5/14	M7 0,6	6034276	27,6/30,8	M7 0,6
6034120	12/14,5	M7 0,6	6034284	28,4/31,6	M7 0,6
6034123	12,3/14,8	M7 0,6	6034299	29,9/33,1	M7 0,6
6034128	12,8/15,3	M7 0,6	6034314	31,4/34,5	M7 0,6
6034132	13,2/15,7	M7 0,6	6034329	32,9/42,5	M7 0,6
6034137	13,7/16,2	M7 0,6	6034393	39,3/42,5	M7 0,6
6034141	14,1/16,6	M7 0,6	6034408	40,8/44	M7 0,6
6034143	14,3/16,8	M7 0,6	6034655	65,5/67,3	M7 0,6
6034145	14,5/17	M7 0,6	6034663	66,3/69,5	M7 0,6
6034145B	14,5/17,8	M7 0,6			



DUBBELE KLEM
DOUBLE CLAMP
DOPPEL KLEMME

Deze klem met 2 oren is gemaakt van buis W1 kwaliteit en is eenvoudig en daarmee eenmalig vast te zetten met behulp van speciale tang artnr. 603000

This clamp with 2 ears is made of W1 quality tube and is easy to clamp with using special pliers artno. 603000

Dieser Schelle mit 2 Osen ist aus W1 Qualitätsrohr gefertigt und lässt sich mit der Spezialzange art.-nr. 603000 befestigen.

nr.	Ø / Ø	staalbandbreedte
6031003	3/5	M6 0,7 3,5
6031005	5/8	M6 0,7 4
6031007	7/9	M7 0,7 4,6
6031009	9/11	M7 0,9 5,5
6031011	11/13	M7 1 6
6031013	13/15	M7,5 1 6,3
6031015	15/18	M7,5 1,2 7
6031017	17/20	M7,5 1,2 7,6
6031020	20/23	M9 1,3 8,5
6031021	21/25	M9 1,3 9,6
6031022	22/25	M9 1,3 9,6
6031023	23/27	M9 1,4 9,6
6031025	25/28	M9 1,4 9,8
6031028	28/31	M9,5 1,4 10
6031031	31/34	M9,5 1,4 10,4
6031034	34/37	M9,5 1,5 11
6031037	37/40	M10 1,6 11,2
6031040	40/43	M10 1,6 11,5
6031043	43/46	M10 1,6 11,7



ENDLESS BAND
ENDLESS BAND
ENDLESS BAND

RVS - STAINLESS STEEL - NIRO

Roestvrijstalen band W4 (AISI) Voorzien van EPDM rubber. Bandbreedte: 12 mm

nr.	omschrijving	vpe
6012008	8mm breed met 8 losse klemmen lengte 8 meter	1
6012014	14 mm breed met 6 losse klemmen lengte 3 meter	1



TANG VOOR OORKLEMMEN
PLIERS FOR EARCLIP
ZANGE FÜR OHRCLIP

nr.	e.h.
603000	1



**FITWERK
FITTINGS
FITTINGS**



CR BOCHT 90 GRADEN BI/BUI
CR ELBOW MALE/FEMALE
CR WINKELANSCHLUSS

AUSSEN/INNEN

5830010/CR	3/8
5830013/CR	1/2
5830019/CR	3/4
5830025/CR	1"
5830032/CR	1 1/4
5830038/CR	1 1/2
5830050/CR	2"



CR BOCHT 45 GRADEN BI/BUI
CR ELBOW MALE/FEMALE
CR WINKELANSCHLUSS

AUSSEN/INNEN

5822010/CR	3/8
5822013/CR	1/2
5822019/CR	3/4
5822025/CR	1"
5822032/CR	1 1/4
5822038/CR	1 1/2
5822050/CR	2"



CR BOCHT 45 GRADEN BI
CR ELBOW FEMALE
CR WINKELANSCHLUSS

INNENGEWINDE

5824010/CR	3/8
5824013/CR	1/2
5824019/CR	3/4
5824025/CR	1"
5824032/CR	1 1/4
5824038/CR	1 1/2
5824050/CR	2"



CR VERLOOPRING BI/BUI
CR REDUCING COUPLING
MALE/FEMALE
CR REDUZIERSTÜCKE

AUSSEN/INNEN

5860006/CR	1/4 x 3/8
5860013/CR	1/2 x 3/8
5860019/CR	1/2 x 3/4
5860025/CR	3/4 x 1"
5860032/CR	1" x 1 1/4
5860038/CR	1 1/2 x 1 1/4
58601325/CR	1/2 x 1"
58603250/CR	1 1/4 x 2"
58603825/CR	1" x 1 1/2
58605038/CR	2" x 1 1/2



CR SLANGPILAAR BUITENDRAAD
CR HOSE CONNECTOR MALE
CR SCHLAUCHANSCHLÜSSE

AUSSENGEWINDE

53270606/CR	1/4 x 6 mm
53270608/CR	1/4 x 8 mm
53270610/CR	1/4 x 10 mm
53271008/CR	3/8 x 8 mm
53271010/CR	3/8 x 10 mm
53271013/CR	3/8 x 13 mm
53271016/CR	3/8 x 16 mm
53271310/CR	1/2 x 10 mm
53271313/CR	1/2 x 13 mm
53271316/CR	1/2 x 16 mm
53271320/CR	1/2 x 19 mm
53271915/CR	3/4 x 15 mm
53271920/CR	3/4 x 20 mm
53271925/CR	3/4 x 25 mm
53272520/CR	1" x 20 mm
53272525/CR	1" x 25 mm
53272532/CR	1" x 32 mm
53273225/CR	1 1/4 x 25 mm
53273232/CR	1 1/4 x 32 mm
53273238/CR	1 1/4 x 38 mm
53273832/CR	1 1/2 x 32 mm
53273840/CR	1 1/2 x 40 mm
53273850/CR	1 1/2 x 50 mm
53275050/CR	2" x 50 mm



CR DUBBELNIPPEL 2 X BUI
CR DOUBLENIPPEL 2 X MALE
CR DOPPELNIPPEL 2 X AUSSEN

5855006/CR	1/4
5855010/CR	3/8
5855013/CR	1/2
5855019/CR	3/4
5855025/CR	1"
5855032/CR	1 1/4
5855038/CR	1 1/2
5855050/CR	2"



CR SLANGPILAAR BINNENDRAAD
CR HOSE CONNECTOR FEMALE
CR SCHLAUCHANSCHLÜSSE

INNENGEWINDE

53280610/CR	1/4 x 10 mm
53281010/CR	3/8 x 10 mm
53281014/CR	3/8 x 13 mm
53281313/CR	1/2 x 13 mm
53281316/CR	1/2 x 16 mm
53281320/CR	1/2 x 20 mm
53281920/CR	3/4 x 20 mm
53281925/CR	3/4 x 25 mm
53282525/CR	1" x 25 mm
53283232/CR	1 1/4 x 32 mm
53283240/CR	1 1/4 x 40 mm
53283838/CR	1 1/2 x 38 mm
53283850/CR	1 1/2 x 50 mm
53285050/CR	2" x 38 mm

CR KOGELKRAAN 2 X BI
CR BALLVALVE 2 X FEMALE
CR KUGELHAHN 2 X INNEN



CR SOK
CR JOINT SLEEVES
CR ROHRMUFFEN

5835010/CR	3/8
5835013/CR	1/2
5835019/CR	3/4
5835025/CR	1"
5835032/CR	1 1/4
5835038/CR	1 1/2
5835050/CR	2"



CR VERLOOPNIPPEL 2 X BUI
CR DOUBLE REDUCING NIPPEL
2 X MALE
CR REDUZIERDOPPELNIPPEL
2 X AUSSEN

5850006/CR	1/4 x 3/8
5850013/CR	1/2 x 3/8
5850019/CR	3/4 x 1/2
5850025/CR	1" x 3/4
58501325/CR	1/2" x 1"
5850032/CR	1 1/4" x 1"
5850032/CR	1 1/4" x 2"
5850038/CR	1 1/2" x 1 1/4"
5850050/CR	2" x 1 1/2"

5243010	3/8
5243013	1/2
5243019	3/4
5243025	1"
5243032	1 1/4
5243038	1 1/2
5243050	2"

CR HUIDDOORVOER
CR THREADED THRU HULL
FITTING
CR BORDDURCHLÄSSE

5810010/CR	3/8
5810013/CR	1/2
5810019/CR	3/4
5810025/CR	1"
5810032/CR	1 1/4
5810038/CR	1 1/2
5810050/CR	2"

CR HUIDDOORVOER
MET ZEEF
CR THRU HULL
SCOOPSTRAINER
CR WASSERLÖFFEL

5811010/CR	3/8
5811013/CR	1/2
5811019/CR	3/4
5811025/CR	1"
5811032/CR	1 1/4
5811038/CR	1 1/2

CR BOCHT 90 GRADEN BI/BUI
CR ELBOW FEMALE
CR WINKELANSCHLUSS

INNENGEWINDE

5825006/CR	1/4
5825010/CR	3/8
5825013/CR	1/2
5825019/CR	3/4
5825025/CR	1"
5825032/CR	1 1/4
5825038/CR	1 1/2
5825050/CR	2"

CR T-STUK BINNENDRAAD
CR T-CONNECTOR FEMALE
CR T-ANSCHLÜSSE

INNENGEWINDE

5820010/CR	3/8
5820013/CR	1/2
5820019/CR	3/4
5820025/CR	1"
5820032/CR	1 1/4
5820038/CR	1 1/2
5820050/CR	2"



CR KOPPELING 3-DELIIG BI-BI
CR COUPLING 3-PARTS FEM/FEM
CR KUPLUNG 3-TEILIG INNEN/INNEN

CR KOPPELING 3-DELIIG BI-BU
CR COUPLING 3-PARTS FEM/MALE
CR KUPLUNG 3-TEILIG AUSSEN/INNEN

CR DRAADEIND
CR EXTENSION
CR VERLANGERSTUCK

CR MOER ZONDER RING
CR CR NUT WITHOUT WASHER MUTTER
CR HONE UNTERLEGSCHIEBE

nr.	maat
5835125/CR	1"
5835132/CR	1¼"
5835138/CR	1½"
5835150/CR	2"

nr.	maat
5836125/CR	1"
5836132/CR	1¼"
5836138/CR	1½"
5836150/CR	2"

Lengte / length / länger 1 meter

nr.	maat
5817013/CR	½
5817019/CR	¾
5817025/CR	1"

nr.	maat
58670013/CR	½
58670019/CR	¾
58670025/CR	1"
58670032/CR	1¼
58670038/CR	1½
58670050/CR	2"



CR DOP SOK BINNENDRAAD
CR THREAD FEMALE
CR BLINDSTOPFEN
 INNENGEWINDE

CR PLUG BUITENDRAAD
CR THREAD PLUGS MALE
CR BLINDSTOPFEN
 AUSSERGEWINDE

CR LOSSE RING
CR WASHER
CR UNTERLEGSCHIEBE

nr.	verp.eenheid	maat
5840006/CR	5	¼
5840010 /CR	5	⅜
5840013/CR	5	½
5840019/CR	5	¾
5840025/CR	5	1"
5840032/CR	1	1¼
5840038/CR	1	1½
5840050/CR	1	2"

nr.	verp.eenheid	maat
5845003/CR	5	⅛
5845006/CR	5	¼
5845010 /CR	5	⅜
5845013/CR	5	½
5845019/CR	5	¾
5845025/CR	5	1"
5845032/CR	1	1¼
5845038/CR	1	1½
5845050/CR	1	2"

nr.	maat
586400013/CR	½
586400019/CR	¾
586400025/CR	1"
586400032/CR	1¼
586400038/CR	1½
586400050/CR	2"



PP FITWERK

POLY PROPYLEN / POLY PROPYLENE
MEERDERE PP FITWERK OP AANVRAAG LEVERBAAR



PP HUIDDOORVOER
PP THREADED SKINFITTING
PP BORDDURCHLÄSSE

5658013	○	1/2
5658019	○	3/4
5658025	○	1"
5658032	○	1 1/4
5658038	○	1 1/2
5658050	○	2"



PP HUIDDOORVOER
PP THREADED SKINFITTING
PP BORDDURCHLÄSSE

5645013	●	1/2
5645019	●	3/4
5645025	●	1"
5645032	●	1 1/4
5645038	●	1 1/2
5645050	●	2"



AFB A



AFB B

PP KOGELKRAAN 2 X BI
PP BALLVALVE 2 X FEMALE
PP KUGELHAHN 2 X INNEN

5620013	A	1/2
5620019	A	3/4
5620025	A	1"
5620032	B	1 1/4
5620038	B	1 1/2
5620050	B	2"



PP BOCHT 90 GRADEN 2 X BI
PP ELBOW 2 X FEMALE
PP WINKELANSCHLUSS
2 X INNEN

5630013	1/2
5630019	3/4
5630025	1"
5630032	1 1/4
5630038	1 1/2
5630050	2"



PP T-STUK
PP T-CONNECTOR
PP T-STÜCKE

5618013	1/2
5618019	3/4
5618025	1"
5618032	1 1/4
5618038	1 1/2
5618050	2"



PP BOCHT 90 GRADEN BI/BI
PP ELBOW MALE/FEMALE
PP WINKELANSCHLUSS
AUSSEN/INNEN

5628013	1/2
5628019	3/4
5628025	1"
5628032	1 1/4



PP VERLOOPNIPPEL
PP REDUCING NIPPEL
PP REDUZIERNIPPEL

5660013	1/2 x 3/8 mm
5660019	3/4 x 1/2 mm
5660025	1" x 3/4 mm
5660032	1 1/4" x 1" mm
5660038	1 1/2" x 1" mm
56603832	1 1/2" x 1 1/4" mm
5660050	2" x 1 1/2" mm



PP DUBBELNIPPEL 2 X BUI
PP DOUBLENIPPEL 2 X MALE
PP DOPPELNIPPEL 2 X AUSSEN

5615013	1/2
5615019	3/4
5615025	1"
5615032	1 1/4
5615038	1 1/2
5615050	2"



PP NEUSSTUK
PP SLEEVE
PP ROHRMUFF

5770019	3/4 x 1/2
---------	-----------



PP VERLOOPRING BI/BI
PP REDUCING COUPLING
MALE/FEMALE
PP REDUZIERSTÜCKE
AUSSEN/INNEN

56321913	3/4 x 1/2"
56322513	1" x 1/2"
56322519	1" x 3/4"
56323213	1 1/4 x 1/2"
56323219	1 1/4 x 3/4"
56323225	1 1/4 x 1"
56323819	1 1/2 x 3/4"
56323825	1 1/2 x 1"
56323832	1 1/2 x 1 1/4"
56325025	2 x 1"
56325032	2 x 1 1/4"
56325038	2 x 1 1/2"



PP SLANGPILAAR BUITENDRAAD
PP HOSE CONNECTOR MALE
PP SCHLAUCHANSCHLÜSSE
AUSSENGEWINDE

56101310	1/2 x 10 mm
56101313	1/2 x 13 mm
56101316	1/2 x 16 mm
56101320	1/2 x 20 mm
56101325	1/2 x 25 mm
56101913	3/4 x 13 mm
56101916	3/4 x 16 mm
56101920	3/4 x 20 mm
56101925	3/4 x 25 mm
56102520	1" x 20 mm
56102525	1" x 25 mm
56102532	1" x 32 mm
56103225	1 1/4 x 25 mm
56103232	1 1/4 x 32 mm
56103238	1 1/4 x 38 mm
56103838	1 1/2 x 38 mm
56103850	1 1/2 x 50 mm
56105050	2" x 50 mm



PP SLANGPILAAR BUITENDRAAD
PP HOSE CONNECTOR MALE
PP SCHLAUCHANSCHLÜSSE
AUSSENGEWINDE

56202920	●	3/4 x 20 mm
----------	---	-------------





PP TANKADAPTER/DOORVOER
PP TANKADAPTER/FITTING
PP TANKADAPTER/DURCHFÜHRUNG

Deze is van 1 kant te monteren. Ideaal bij moeilijke bereikbaarheid.
 Can be mounted from 1 side. Ideal if it is difficult to reach.
 Diese kann von 1 seite montiert werden. Ideal, wenn es schwer zu erreichen ist.

Wanddikte: 2>10 mm
 Wallthickness: 2>10 mm
 Wandstärke: 2>10 mm

nr.	G1	E	E1	D	H	L2	K
5741050303	1/2"	29	37	13	49	5	28
5741050505	3/4"	35	43	18	52	4	32
5741050707	1"	43	53	24	56	7	41
5741050909	1 1/4"	52	62	29,5	65	6	50
5741051111	1 1/2"	59	68	34,5	75	16	57
5741051515	2"	70	80	34,5	91	31	70

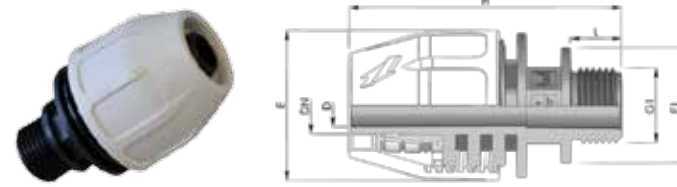

**PP BD FAST COMPACT RECHTE KOPPELING
 VOOR GEBRUIK MET SLANG**
**PP BD FAST COMPACT STRAIGHT COUPLING
 FOR USE WITH HOSE**
**PP BD SCHNELLE KOMPAKTE GERADE KUP-
 PLUNG ZUR VERWENDUNG MIT SCHLAUCH**

16 bar bij 20 graden
 -5>80 graden

nr.	DN mm (inch)	G1	D	L	H	E	E1
5740050210	10 (3/8")	1/2"	7,5	11	91	34,5	32
5740050313	13 (1/2")	1/2"	9,5	14,5	77	38	32
5740050316	16 (5/8")	1/2"	12	14,5	83	42	32
5740050320	20 (25/32")	1/2"	15	14,5	88	49	32
5740050513	13 (1/2")	3/4"	9,5	16	80	38	38
5740050516	16 (5/8")	3/4"	12	16	85	42	38
5740050520	20 (25/32")	3/4"	15	16	90	49	39



KLEINE WIERPOT 3/4 COMPLEET
STRAINER COMPLETE 3/4
WASSERFILTER COMPLET 3/4

8610019
 8611019 Losse sleutel / spare key
 Schlüssel
 8610019.2 Uitvoering metalen deksel
 Version metal cap
 Version mit Metal Deckel



ONTLUCHTINGSNIPPELS PLAT
FUELVENT FLAT
ENTLUFTUNGSNIPPE;

58711116 Haaks/elbow/winkel 16
 58722216 Recht/straight/gerade 16



BELUCHTER / OVERLOOP
AERATOR / OVERFLOW
BELÜFTER / ÜBERLAUF

58733319 A 1/2 x 3/4 x 3/4
 58733332 A 1/2 x 1 1/4 x 1 1/4
 58744413 B 1/2 x 10 mm



HUIDDOORVOER
THREADED SKINFITTING
FLARED HEAD
SCHRÄGER BORDDURCHLÄSSE NUR GEWINDE

5810006 1/4
 5810010 3/8
 5810013 1/2
 5810019 3/4
 5810025 1"
 5810032 1 1/4
 5810038 1 1/2
 5810050 2"



VERCHROOMDE HUIDDOORVOER
CHROMET PLATED BRASS
VERCHROMTES MESSING
HOL / FLAT HEAD / FLACH

5814010 3/8
 5814013 1/2
 5814019 3/4
 5814025 1"
 5814032 1 1/4
 5814038 1 1/2

NBR RINGEN
RINGS **RINGE**

huiddoorvoer / skinfitting / borddurchlässe
 22123 1/4
 35173 3/8
 30213 1/2
 39293 3/4
 53343 1"
 65433 1 1/4
 70483 1 1/2



MESSING HUIDDOORVOER MET ZEEF
THRU HULL SCOOPSTRAINER
WASSERLÖFFEL

5811010 3/8
 5811013 1/2
 5811019 3/4
 5811025 1"
 5811032 1 1/4
 5811038 1 1/2
 5811050 2"



MESSING HUIDDOORVOER
BRASS SKINFITTING
GEWÖLBTER BORDDURCHLÄSSE
 100 mm lang / long / länger

5810113 1/2
 5810119 3/4
 5810125 1"
 5810132 1 1/4
 5810138 1 1/2



DEKVULDOP MET SLEUTEL
DECK FILLER WITH KEY
EINFULLSTÜTZEN MIT SCHLUSSELN

5809238 water / water / wasser 38 mm
 5809138 diesel / fuel / Treibstoff 38 mm
 5809250 water / water / wasser 50 mm
 5809150 diesel / fuel / Treibstoff 50 mm



VERCHROOMDE HUIDDOORVOER
CHROMET PLATED BRASS
VERCHROMTES MESSING
BOL / ROUNDED / GEWÖLBTER

5812010 3/8
 5812013 1/2
 5812019 3/4
 5812025 1"
 5812032 1 1/4
 5812038 1 1/2



MESSING HUIDDOORVOER
MET SLANGPILAAR
WITH HOSECONNECTOR
MIT SCHLAUCHANSLUCK

5818013 13 1/2
 5818016 15 3/8
 5818019 19 3/4
 5818025 25 1"
 5818032 32 1 1/4
 5818038 38 1 1/2

KOELWATERFILTER
COOLINGWATERSTRAINER
KÜHLWASSERFILTER



Met transparante deksel, zij-onder uitlaat
 With transparant cap, side-under
 Mit klarsichte Deckel, Side-Under

8615025 1"
 8615038 1 1/2
 8615050 2"
 8615065 2 1/2
 8615075 3"

Ook op aanvraag in CR leverbaar

KOELWATERFILTER
COOLINGWATERSTRAINER
KÜHLWASSERFILTER



Bodemmontage - floor mounting - bodenbefestigung
 Koelwaterfilter 2x zijuitlaat

8620025 1"
 8620038 1 1/2
 8620050 2"
 8620065 2 1/2
 8620075 3"

MESSING DRAADEIND
EXTENSION
VERLANGERSTUCK

Lengte / length / länger 1 meter
 5817013 1/2
 5817019 3/4
 5817025 1"
 5817032 1 1/4
 5817038 1 1/2
 5817050 2"





**MESSING BOCHT
90 GRADEN BI/BUI**
BRASS ELBOW MALE/FEMALE
**MESSING WINKEL
ANSCHLUSS AUSSEN/INNEN**

5830003	5	1/8
5830006	5	1/4
5830010	5	3/8
5830013	5	1/2
5830019	5	3/4
5830025	5	1"
5830032	1	1 1/4
5830038	1	1 1/2
5830050	1	2"



**MESSING BOCHT
45 GRADEN 2 X BI**
BRASS ELBOW 2 X FEMALE
**MESSING WINKEL
ANSCHLUSS 2 X INNEN**

5824010	1	3/8
5824013	1	1/2
5824019	1	3/4
5824025	1	1"
5824032	1	1 1/4
5824038	1	1 1/2
5824050	1	2"



**MESSING BOCHT
45 GRADEN BI/BUI**
BRASS ELBOW MALE/FEMALE
**MESSING WINKEL
ANSCHLUSS AUSSEN/INNEN**

5822010	1	3/8
5822013	1	1/2
5822019	1	3/4
5822025	1	1"
5822032	1	1 1/4
5822038	1	1 1/2
5822050	1	2"



MESSING T-STUK 3 X BI
BRASS T-CONNECTOR
3 X FEMALE
**MESSING T-STÜCKE
3 X INNEN**

5820003	5	1/8
5820006	5	1/4
5820010	5	3/8
5820013	5	1/2
5820019	5	3/4
5820025	5	1"
5820032	1	1 1/4
5820038	1	1 1/2
5820050	1	2"



MESSING SOK BINNENDRAAD
BRASS JOINT SLEEVES
FEMALE
**MESSING ROHRMUFFEN
INNENGEWINDE**

5835004	5	1/8
5835006	5	1/4
5835010	5	3/8
5835013	5	1/2
5835019	5	3/4
5835025	5	1"
5835032	1	1 1/4
5835038	1	1 1/2
5835050	1	2"



**MESSING BOCHT 90
GRADEN 2 X BI**
BRASS ELBOW 2 X FEMALE
**MESSING WINKEL
ANSCHLUSS 2 X INNEN**

5825003	5	1/8
5825006	5	1/4
5825010	5	3/8
5825013	5	1/2
5825019	5	3/4
5825025	5	1"
5825032	1	1 1/4
5825038	1	1 1/2
5825050	1	2"



**MESSING VERLOOP-
NIPPEL MET ZESKANT**
**BRASS DOUBLE NIPPLE
REDUCED**
**MESSING REDUKTION
DOPPELNIPPEL**

5850003	5	1/8 x 1/4
58500613	5	1/4 x 1/2
5850006	5	1/4 x 3/8
5850013	5	3/8 x 1/2
5850019	5	1/2 x 3/4
5850025	5	3/4 x 1"
5850032	1	1" x 1 1/4
5850038	1	1 1/4 x 1 1/2
5850050	1	1 1/2 x 2"



**MESSING DUBBELNIPPEL
MET ZESKANT**
BRASS DOUBLENIPPEL
MESSING DOPPELNIPPEL

5855003	5	1/8
5855006	5	1/4
5855010	5	3/8
5855013	5	1/2
5855019	5	3/4
5855025	5	1"
5855032	1	1 1/4
5855038	1	1 1/2
5855050	1	2"

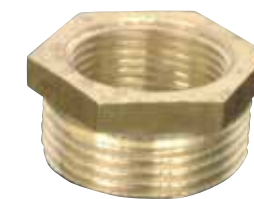

**MESSING VERLOOPRING
BI/BUI**
**BRASS REDUCING
COUPLING MALE/FEMALE**
**MESSING REDUZIER-
STÜCKE AUSSEN/INNEN**

58600313	5	1/8 x 1/2
58600319	5	1/8 x 3/8
5860003	5	1/4 x 1/8
5860006	5	1/4 x 3/8
58600619	5	1/4 x 3/4
58601019	5	3/8 x 3/4
58601025	5	3/8 x 1"
58600613	5	1/2 x 1/4
5860013	5	1/2 x 3/8
58601325	5	1/2 x 1"
58601332	1	1/2 x 1 1/4
5860019	5	3/4 x 1/2
5860025	5	1" x 3/4
58603219	1	1 1/4 x 3/4
5860032	1	1 1/4 x 1"
5860038	1	1 1/2 x 1 1/4
58603819	1	1 1/2 x 3/4
58603825	1	1 1/2 x 1"
58605038	1	2" x 1 1/2



MESSING VERLOOPSOK BI
**BRASS REDUCED
PIPESLEEVE FEMALE**
**MESSING REDUZIER
MUFFEN INNEN**

5836004	1	1/4 x 1/8
5836006	1	1/4 x 3/8
58360613	1	1/4 x 1/2
5836013	1	1/2 x 3/8
58361325	1	1/2 x 1"
5836019	1	3/4 x 1/2
5836025	1	1" x 3/4
5836032	1	1 1/4 x 1"
5836038	1	1 1/2 x 1 1/4



MESSING DOP SOK BI
BRASS THREAD FEMALE
**MESSING BLINDSTOPFEN
INNENGEWINDE**

5840004	5	1/8
5840006	5	1/4
5840010	5	3/8
5840013	5	1/2
5840019	5	3/4
5840025	5	1"
5840032	1	1 1/4
5840038	1	1 1/2
5840050	1	2"



MESSING PLUG BUITENDRAAD
BRASS THREAD PLUGS MALE
**MESSING BLINDSTOPFEN
AUSSENGEWINDE**

5845003	5	1/8
5845006	5	1/4
5845010	5	3/8
5845013	5	1/2
5845019	5	3/4
5845025	5	1"
5845032	1	1 1/4
5845038	1	1 1/2
5845050	1	2"

MESSING SLANGPILAAAR BUITENDRAAD
HOSE CONNECTOR MALE
SCHLAUCHANSCHLUSS AUSSENGEWINDE



nr.	verp.eenheid	maat	tule
53270306	5	1/8	6
53270308	5	1/8	8
53270310	5	1/8	10
53270606	5	1/4	6
53270608	5	1/4	8
53270610	5	1/4	10
53270613	5	1/4	13
53270616	5	1/4	16
53271008	5	3/8	8
53271010	5	3/8	10
53271013	5	3/8	13
53271016	5	3/8	16
53271308	5	1/2	8
53271310	5	1/2	10
53271313	5	1/2	13
53271316	5	1/2	16
53271320	5	1/2	20

nr.	verp.eenheid	maat	tule
53271913	5	3/4	13
53271915	5	3/4	16
53271920	5	3/4	20
53271925	5	3/4	25
53272520	5	1"	20
53272525	5	1"	25
53272532	5	1"	32
53273225	1	1 1/4	25
53273232	1	1 1/4	32
53273238	1	1 1/4	39
53273832	1	1 1/2	32
53273838	1	1 1/2	38
53273845	1	1 1/2	45
53273850	1	1 1/2	50
53275045	1	2"	45
53275050	1	2"	51
53275060	1	2"	60
53276565	1	2 1/2	65
53277676	1	3"	76



MESSING SLANGPILAAAR
HOSE CONNECTOR
SCHLAUCHANSCHLUSS

BINNENDRAAD / FEMALE / INNENGEWINDE

nr.	verp.eenheid	maat	tule
53280610	5	1/4	10
53281010	5	3/8	10
53281014	5	3/8	13
53281015	5	3/8	16
53281313	5	1/2	13
53281316	5	1/2	16
53281320	5	1/2	20
53281920	5	3/4	20
53281925	5	3/4	25
53282525	5	1"	25
53283232	1	1 1/4	32
53283838	1	1 1/2	38
53285050	1	2"	50



NEUSSTUK
SLEEVE
ROHRMUFF

nr.	verp.eenheid	maat
58700603	1	1/4 x 1/8
58701006	1	3/8 x 1/4
58701306	1	1/2 x 1/4
58701310	1	1/2 x 3/8
58701913	1	3/4 x 1/2
58702519	1	1" x 3/4



LOSSE RING
WASHER
UNTERLEGSCHIEBE

nr.	maat
586400006	1/4
586400010	3/8
586400013	1/2
586400019	3/4
586400025	1"
586400032	1 1/4
586400038	1 1/2
586400050	2"



MESSING CONNECTIEMOER
BRASS CONNECTIONNUT
MESSING VERBINDUNGS-
MUTTER

MET FLENS / WITH FLANGE / MIT FLANSCH

nr.	verp.eenheid	maat
58650010	1	3/8
58650013	1	1/2
58650019	1	3/4
58650025	1	1"
58650032	1	1 1/4
58650038	1	1 1/2
58650050	1	2"



LOSSE MOER
NUT WITHOUT WASHER
MUTTER OHNE UNTER-
LEGSCHIEBE

nr.	maat
58670006	1/4
58670010	3/8
58670013	1/2
58670019	3/4
58670025	1"
58670032	1 1/4
58670038	1 1/2
58670050	2"



MESSING 3-DELIGE
KOPPELING BI/BUI
BRASS 3-PIECE COUPLING IN/OUT
MESSING 3-TEILIGE
KUPPLUNG IHN/AUS

nr.	maat
5836106	1/4
5836110	3/8
5836115	1/2
5836119	3/4
5836125	1
5836132	1 1/4
5836138	1 1/2
5836150	2
5836165	2 1/2
5836176	3



MESSING 3-DELIGE
KOPPELING 2 X BI
BRASS 3-PIECE COUPLING
2 X INSIDE
MESSING 3-TEILIGE
KUPPLUNG 2 X IHENEN

nr.	maat
5835119	3/4
5835125	1
5835150	2

GEKA SNELKOPPELINGEN VOOR WATER EN LUCHT
GEKA QUICKCOUPLING FOR WATER AND AIR
GEKA SCHNELLKUPPLUNG FÜR WASSER UND LUFT

Nokafstand / camdistance / Nockenabstand: 40 mm

Werkdruk / workload / Arbeitsbelastung: • Voor water/for water/für wasser: max. 40 bar • Voor lucht /for air/für luft: max. 30 bar



AANSLUITSTUK
CONNECTION PIECE
VERBINDUNGSSTÜCK

VOOR SLANG - FOR HOSE - FÜR SLAUCH

nr.	⊘
5310010	10
5310013	13
5310016	16
5310019	19
5310025	25
5310032	32
5310038	38



AANSLUITSTUK
CONNECTION PIECE
VERBINDUNGSSTÜCK

MET BINNENDRAAD BSP - WITH BSP FEMALE
 THREAD - MIT BSP INNENGEWINDE

nr.	⊘
5311010	3/8
5311013	1/2
5311019	3/4
5311025	1"
5311032	1 1/4
5311038	1 1/2



AANSLUITSTUK
CONNECTION PIECE
VERBINDUNGSSTÜCK

MET BUITENDRAAD BSP - WITH BSP MALE
 THREAD - MIT BSP AUSSENGEWINDE

nr.	⊘
5312010	3/8
5312013	1/2
5312019	3/4
5312025	1"
5312032	1 1/4
5312038	1 1/2



MESSING BLINDKAP **BLIND CAPS** **BLINDKAPPE**

VOOR ALLE KOPPELINGEN - FOR ALL COUPLINGS - FÜR ALLE KUPPLUNGEN

nr.
5313040



MESSING VEERBELASTE VOETKLEP
SPRING-LOADED VALVE WITH SUCTION STRAINER
RÜCKSCHLAGVENTILL MIT ANSUNGSIEB

MESSING VEERBELASTE TUSSENKLEP
BRASS SPRING-LOADED INTERMEDIATE VALVE
RÜCKSCHLAGVENTILL AUS MESSING

nr.	bi / fem / innen	H x B	werkdruk bar
5225013	½	67 x 34	10
5225019	¾	78 x 42	10
5225025	1"	92 x 48	10
5225032	1¼	104 x 56	8
5225038	1½	118 x 71	8
5225050	2"	134 x 88	8

nr.	bi / fem / innen	↕ x ↔	werkdruk bar
5226013	½	48 x 34	12
5226019	¾	53 x 42	12
5226025	1"	58 x 48	12
5226032	1¼	67 x 56	10
5226038	1½	76 x 71	10
5226050	2"	80 x 88	10



TUSSENKLEP MET HANGENDE KLEP
INTERMEDIATE VALVE WITH HANGING VALVE
ZWISCHENVENTIL MIT HÄNGENDEM VENTIL

MESSING SLANG VERBINDINGSPIJPJES
BRASS CONNECTOR
MESSING VERLÄNGERUNGEN

Lengte / length / lange: +/- 6 cm.

5228013	½
5228019	¾
5228025	1"
5228032	1¼
5228038	1½
5228050	2"

5330006	6
5330008	8
5330010	10
5330013	13
5330019	19
5330025	25
5330032	32
5330038	38



NYLON Y-STUK VOOR SLANG
NYLON Y-PIECE FOR HOSE
NYLON 7-STÜCK FOR SLAUCH

NYLON VERBINDINGSPIJP
CONNECTINGPIPE
VERBINDUNGSROHR
VOOR SLANG - FOR HOSE - FÜR SLAUCH

NYLON T-STUK VOOR SLANG
NYLON T-SLEAVE FOR HOSE
NYLON T-STÜCK FÜR SLAUCH

nr.	∅
5332113	13
5332116	16
5332119	19

nr.	∅
5331006	6
5331008	8
5331010	10
5331013	13
5331016	16
5331019	19
5331025	25

nr.	∅
5332006	6
5332008	8
5332010	10
5332013	13
5332016	16
5332019	19
5332025	25



AARDING AANSLUITING
VOOR GEBRUIK MET HUIDDOORVOEREN
BRASS WASHER
WITH GROUND WIRE FITTING
MESSING UNTERLEGSCHIEBE
MIT ERDUNGSKABELANSCHLUSSE

TEFLONTAPE
TEFLON BAND

VIBA

nr.	
9992218	1

nr.		
9992212	1110 H	1
9990645	1346	1

nr.	maat
5865110	¾
5865113	1½
5865119	¾
5865125	1"
5865132	1¼
5865138	1½
5865150	2"



VERDELER
MANIFOLD
VERTEILER

nr.	∅	∅
581932134	A: 1¼	B: ½



CR KOGELKRAAN BI/BI
CR BALL VALVE FEM/FEM
CR KUGELHÄHNE INNEN/INNEN

5243010	3/8
5243013	1/2
5243019	3/4
5243025	1"
5243032	1 1/4
5243038	1 1/2
5243050	2"



MESSING KOGELKRAAN BI/BI
BRASS BALL VALVE FEM/FEM
MESSING KUGELHÄHNE
 INNEN/INNEN

5550006	1/4
5550010	3/8
5550013	1/2
5550019	3/4
5550025	1"
5550032	1 1/4
5550038	1 1/2
5550050	2"
5550065	2 1/2
5550076	3"



MESSING KOGELKRAAN BI/BI
BRASS BALL VALVE MALE/FEM
MESSING KUGELHÄHNE
 AUSSEN/INNEN

5251006	1/4
5251010	3/8
5251013	1/2
5251019	3/4
5251025	1"
5251032	1 1/4
5251038	1 1/2
5251050	2"



MESSING VERCHROOMDE
3-WEG KOGELKRAAN
3-WAY BALL VALVE
3-WEGE KUGELHÄHNE
 LICHTE UITVOERING / LIGHT VERSION

L-boring

5280010	3/8
5280013	1/2
5280019	3/4
5280025	1"
5280032	1 1/4
5280038	1 1/2



MESSING VERCHROOMDE
3-WEG KOGELKRAAN
3-WAY BALL VALVE
3-WEGE KUGELHÄHNE
 ZWARE UITVOERING / HEAVY VERSION

L-boring en massieve kogel

5281013	1/2
5281019	3/4
5281025	1"
5281032	1 1/4
5281038	1 1/2
5281050	2"



KOGELKRAAN MET
VORSTBESCHERMING BI/BI
BRASS BALL VALVE WITH
FROSTPROTECTION FEM/FEM
KUGELHÄHNE MIT
FROSTSCHUTZ INNEN/INNEN

5248013	1/2
5248019	3/4
5248025	1"
5248032	1 1/4
5248038	1 1/2



MINI KOGELKRAAN BI/BI
MINI BALL VALVE FEM/FEM
MINI KUGELHÄHNE
 INNEN/INNEN

Verchromd / chromed / verchromtes
 Temp.: - 30°C tot + 180°C
 Werkdruk/pressure: 15 bar

5241006	8	1/4
5241010	8	3/8
5241013	10	1/2



MINI KOGELKRAAN BI/BI
MINI BALL VALVE MALE/FEM
MINI KUGELHÄHNE
 AUSSEN/INNEN

Verchromd / chromed / verchromtes
 Temp.: - 30 °C tot + 180 °C
 Werkdruk/pressure: 15 bar

5242006	8	1/4
5242010	8	3/8
5242013	10	1/2



SNELSLUITKRAAN BRONS
 BI/BI
QUICK CLOSING SLIDE
VALVE FEM/FEM
SCHNEL SCHLIESSENDER
SCHIEBER INNEN/INNEN

5577010	3/8
5577013	1/2
5577019	3/4
5577025	1"



YPSILON KRAAN
YPSILON BALL VALVE
YPSILON KUGELHÄHNE

5288013	1/2 x 1/2 x 3/8
5288019	3/4 x 1/2 x 1/2
5288025	1 x 3/4 x 3/4
5288032	1 1/4 x 1 x 1



A



B

PP KOGELKRAAN BI/BI
PP BALL VALVE FEM/FEM
PP KUGELHÄHN INNEN/INNEN

5620013	A	1/2
5620019	A	3/4
5620025	A	1"
5620032	B	1 1/4
5620038	B	1 1/2
5620050	B	2"



CAV BRANDSTOFFILTER
CAV DIESELFILTER
CAV KRAFTSTOFF FILTER

Diesel brandstoffilter met water-afscheider
 Complete Dieselfilter with waterdrain
 Kraftstoff Filter mit Wasserseparator

nr.	omschrijving	
8501002	CAV 296 compleet	A
	glas / glass / Glas	
8501333	CAV 296 compleet met aluminium / Aluminium	B



LOSSE FILTER 10 STUKS
FILTER ONLY
NUR FILTER

nr.	omschrijving
8500002	Filter type 296
8500012	Setje ringen Set of rings / Satz Ringe



AANSLUITSTUKKEN BSP
BINNENDRAAD
HOSE CONNECTION
1/4 BSP THREAD
STUTZER FÜR 1/4 BSP
GEWINDE

2 STUKS - 2 PIECES - 2 STUCK

nr.	omschrijving
8500004	Aansluitstuk voor 1/4 BSP-binnendraad voor aansluiting met slang pilaar enz.



SLANGTULE PER STUK
DIRECT HOSE NOZZLE
SCHLAUCHANSCHLUSS
FÜR COMPLETES
KRAFTSTOFFILTER

nr.	omschrijving	
8500013	A	8 mm
8500014	B	8 mm



AANSLUITSTUKKEN LEIDING
PIPE CONNECTOR
KOPFERROHRVERBINDUNG
FÜR KRAFTSTOFFILTER

2 STUKS - 2 PIECES - 2 STUCK

nr.	omschrijving
8500003	8 mm



MESSING PLUG
BRASS LOCKERNUT
MESSING BLINDSTOPFEN

nr.	omschrijving
8500005	Messing plug ten behoeve van de CAV brandstoffilter Delphi



PVC PLUG
PVC LOCKERNUT
PVC BLINDSTOPFEN

nr.	omschrijving
8500115	Pvc plug ten behoeve van de CAV brandstoffilter Delphi



VERLOOPNIPPEL
REDUCINGNIPPLE BANJO
REDUZIERNIPPEL BANJO

t.b.v. banjobout te gebruiken bij compleet C.A.V. 296 brandstoffilter.

nr.	omschrijving
8500006	M14 x 1,5



LOS GLAS
GLASS BOWL
LOSES GLAS

nr.	omschrijving
8500008	



SEPAR FILTER & WATER-AFSCHIEDER

nr.	mm	vpe
85032000	140 x 258	1



SEPAR FILTER & WATER-AFSCHIEDER METALEN KOM

nr.	mm	vpe
85032000M	140 x 258	1



SEPAR FILTER

nr.	vpe
85032001	1



KNELKOPPELING 8MM
VOOR SEPAR FILTER

nr.	maat	vpe
8502011	M16x1,5mm - 8mm	1



KNEL KOPPELING VOOR SEPAR FILTER

nr.	maat	vpe
8502012	M16x1,5mm - 10mm	1



SLANGPILAAAR VOOR SEPAR FILTER

nr.	maat	vpe
8502016	M16x1,5mm - 10mm	1
	with 8mm Hose Connector	



BRANDSTOFFILTER VOOR AUTOMOTIVE

nr.	maat	vpe
850310000	116 mm x 166 mm	1



LOS FILTER 10 MICRON

nr.	maat	vpe
85031001		1





GAS FITWERK

MEERDERE GAS FITWERK OP AANVRAAG LEVERBAAR

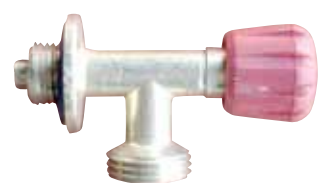

FLENSKRAAN GASBOTTLE COCK GASHÄHN

(COMBI- EN CAMPINGGAS)

nr.	soort
1666248	Flenskraan haaks Flange tap angled Flanschhahn abgewinkelt



KRAAN ENKEL SHUT OFF VALVE ABFANGHAHN

Snel sluitkraan voor 8 mm

nr.	soort
1666237	Enkel

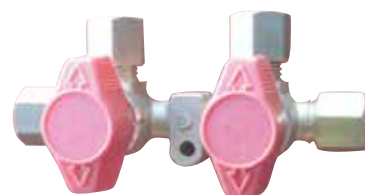

KRAAN DUBBEL SHUT OFF DOUBLE VALVE ABFANGHAHN DOPPELT

WITH FIXING PLATE / MIT MONTAGEPLATTE

Snel sluitkraan voor 8 mm

nr.	soort
1666239	Dubbel

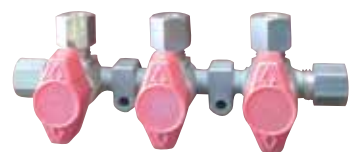

KRAAN 3-DUBBEL SHUT OFF VALVE 3-WAY ABFANGHAHN DREI

WITH FIXING PLATE / MIT MONTAGEPLATTE

Snel sluitkraan voor 8 mm

nr.	soort
1666240	3- Dubbel



KLEPAFSLUITER 12VDC GLOBE VALVE AFSPERRVENTIL

ELECTRISCH / ELECTRONIC
ELEKTRONISCH

2x rechte knel koppeling 8 x 1/4

nr.	soort
991666136	12vdc



DRUKREGELAAR MET AFBLAASVENTIEL PRESSURE REGULATOR WITH BLOW-OFF VALVE DRUCKREGLER MIT ABBLASEVENTIL

Voor caravan of camper

nr.	soort
1666656	30 mbar
1666656-50	50 mbar
1666662	manometer, 30 mbar
1666663	manometer, 50 mbar
1666738	Haaks model, 50mbar
1666749	Haaks model met mamometer, 50 mbar



DRUKREGELAAR PRESSURE REGULATOR DRUCKREGLER

Tbv de watersport

nr.	soort	
1666744	Haaks model	30 mbar
1666440	Recht model	30 mbar



DRUKREGELAAR PRESSURE REGULATOR DRUCKREGLER

MET/WITH/MIT MANOMETER

Tbv de watersport

nr.	soort	
1666743	Haaks model	30 mbar
1666442	Recht model	30 mbar



KOPPELING STRAIGHT GERADE KUPLUNG

nr.	soort	maat in mm
1666801	Rechte koppeling	2 x 8

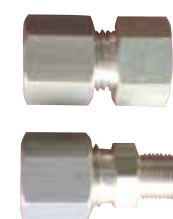

KOPPELING JOINT FOR COPPERPIPE 8MM KUPLUNG FÜR KOPPERROHR

A	nr.	B	maat in mm
	1666810	B	8 x 1/8
	1666811	B	8 x 1/4
	1666812	B	8 x 3/8
B	1666816	A	8 x 3/8



EINDSTOP BLIND LOCKERNUT FOR COPPERPIPE BLINDSTOPF FÜR KOPPERROHR

nr.	maat in mm
1666820	8 mm



T-STUK T-CONNECTOR T-STÜCK FÜR KOPPERROHR

nr.	maat in mm
1666823	3 x 8 mm



KNIE KOPPELING ELBOW JOINT 2X COPPERPIPE WINKELANSCHLUSS 2X KOPPERROHR

nr.	maat in mm
1666827	2 x 8 mm



KNIE KOPPELING ELBOW JOINT WINKELANSCHLUSS

nr.	maat in mm
1666832	uitw. 8 x 1/4



SCHOT KOPPELING BULKHEAD SCHOTTENWAND DURCHGANG

nr.	maat in mm
1666834	2 x 8 mm

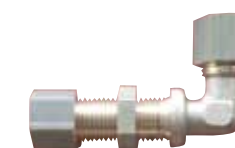

SCHOT KOPPELING HAAKS BULKHEAD ELBOW SCHOTTENWAND WINKEL

nr.	maat in mm
1666837	2 x 8 mm



SCHOT KOPPELING BULKHEAD 1/4 THREADED RH SCHOTTWAND KUPLUNG

nr.	maat in mm
1666414	1/4 links bu.dr. x 8 mm knel



**SLANGPILAAR
HOSE TAIL
GASSCHLAUCHENDE**

8 mm knel, 8 mm, 8 mm rohr mit mutter

nr.

1666332



**SLANGPILAAR OP GRONDPLAAT
HOSETAIL ON BASEPLATE
GASSCHLAUCHENDE AUF
GRUNDPLATTE MIT MUTTER**

nr.

1666331 Rechte kop. 8 mm knel x
slangpilaar op grondplaat

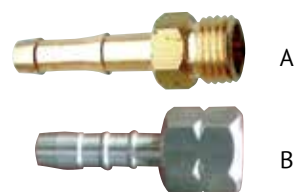

**SLANGPILAAR
HOSETAIL
GASSCHLAUCH
ANSCHLUSSGERADE**

nr.

1666429 A Slangpilaar metrisch
1/4 x 1,5 uitwendig
1666413 B Slangpilaar bi.dr. 1/4
links inwendig wartel



**KLEM-SLANGPILAAR GLAD
HOSETAIL SMOOTH
GASSCHLAUCHANSCHLUSS**

nr.

1666294

mm

8

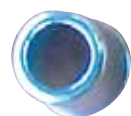

**RVS HULS 16 MM
STAINLESS STEEL SLEEVE
FOR GAS HOSE
EDELSTAHLHÜLSE FÜR
GASSCHLAUCH**

nr.

1666000 16 mm t.b.v. propaangasslang



**MUURBEUGEL
WALL BRACKET
WANDHALTERUNG**

nr.

1666238 voor/for/für 1666237



**KOPEREN LEIDING
COPPER PIPE FOR LIQUID
GAS IN FLOW
KUPFER LEITUNG FÜR
FLÜSSIG GAS**

6 X 8 MM

nr.

1666402

50 mtr

Op gewenste lengte te leveren met toeslag.

Can also be delivered in desired length with surcharge.

Kann auch in der gewünschten Länge gegen Aufpreis geliefert werden.



**LOSSE KNELRINGEN
SPARE OGIVE
ERZATZ KLEMFITTING**

nr.

1666003 A Eindstop knelkoppeling / endstop compression ring
Endanschlag klemverbinding
8 mm
1666281 B Duitse knelring konisch / German conical compression / Deutsche Konus
8 mm
1666306 C Konische knelring / conical compression ring / Konus für mutter
1666727 D Verstevigingsbus / reinforcement sleeve / verstärkungshülse: 8 mm

GEPERSTE GASLANGEN GASINSTALLATION HOSES GASANLAGEN SLAUCHEN



glad / smooth / glatt

nr.

soort

991666001 verL.slang 60 cm 8mm knel x 8mm
991666002 verL.slang 80 cm 8mm knel x 8mm
991666016 verL.slang 100 cm 8mm knel x 8mm



nr.

soort

991666010 verL.slang 60 cm 2x 1/4 li.wartel
991666011 verL.slang 80 cm 2x 1/4 li.wartel
991666012 verL.slang 100 cm 2x 1/4 li.wartel



glad / smooth / glatt

nr.

soort

991666004 verL.slang 60 cm 1/4 li.wartel x 8mm
991666005 verL.slang 80 cm 1/4 li.wartel x 8mm
991666006 verL.slang 100 cm 1/4 li.wartel x 8mm



nr.

soort

991666013 verL.slang 60 cm 2 x 8 mm knel
991666014 verL.slang 80 cm 2 x 8 mm knel
991666015 verL.slang 100 cm 2 x 8 mm knel



nr.

soort

991666007 verL.slang 60 cm 1/4 li.wartel x 8mm knel
991666008 verL.slang 80 cm 1/4 li.wartel x 8mm knel
991666009 verL.slang 100 cm 1/4 li.wartel x 8mm knel



2x glad / 2x smooth / 2x glatt

nr.

soort

991666032 verL.slang 60 cm 2 x 8 mm
991666035 verL.slang 80 cm 2 x 8 mm
991666022 verL.slang 100 cm 2 x 8 mm

CLASS 2-8 MM-10 BAR-PROPANE/BUTANE

**PROPAANGASSLANG
GASINSTALLATION HOSE
GASANLAGEN SLAUCH**

NEN-EN 16436-1

nr.

inw./uitw.

rollengte

3265008.2

8/15

50 meter

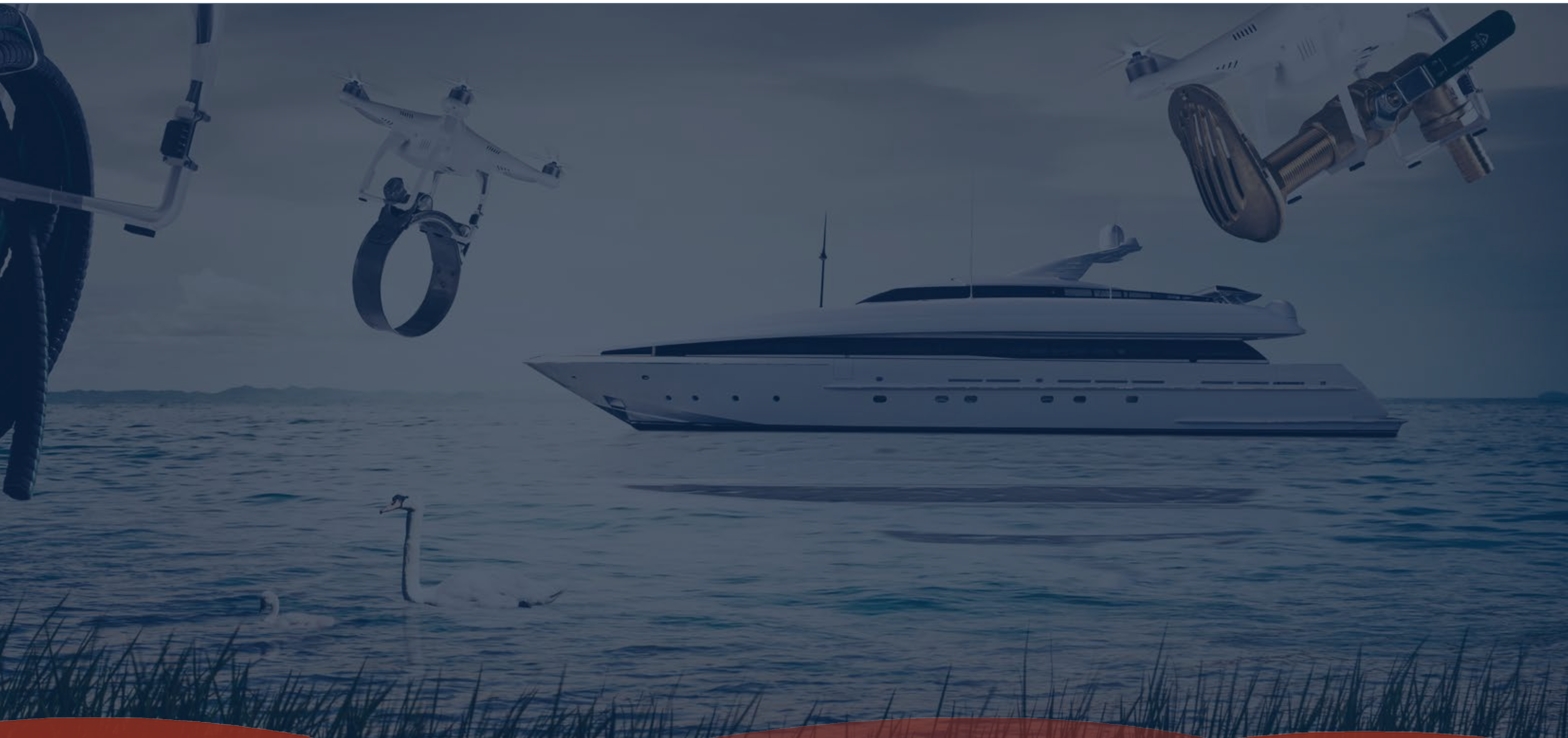

HEP20



HEP20 PB BUIS OP ROL
DIFFUSIE DICHT
HEP20 BARRIER PIPE
DIFFUSION TIGHT

nr.	lengte	maat
156309DD	50 meter	15
156311DD	50 meter	22



RECHTE KOPPELING
2X INSTEK (HD1)
STRAIGHT CONNECTOR

nr.	maat
156100	15 x 15
156101	22 x 22



VERLOOPSTUK SPIE X
INSTEK (HD2)
REDUCE > SPIGOT

nr.	maat
156105	22 x 15



KNIE 90°C
2X INSTEK (HD5)
ELBOW
WINKEL

nr.	maat
156110	15 x 15
156111	22 x 22



T-STUK 3X INSTEK
(HD10)
EQUAL TEE

nr.	maat
156115	15 x 15 x 15
156116	22 x 22 x 22



VERLOOP T-STUK 3X
INSTEK (HD12/HD13/HD14)
REDUCE TEE

nr.	maat
156122	22 x 15 x 15
156121	22 x 15 x 22
156120	22 x 22 x 15



MUURPLAATKOPPELING
BINNENDRAAD
X INSTEK (HX8)

nr.	maat
156275	1/2" bi.dr.x 15



AANSLUITSTUK
BINNENDRAAD
X SPIE (HX30)
BRASS ADAPTER FEMALE

nr.	maat
156165	1/2" BSP x 15
156166	3/4" BSP x 22



AANSLUITSTUK
BUITENDRAAD
X SPIE (HX31)
BRASS ADAPTER MALE

nr.	maat
156170	1/2" BSP x 15
156171	3/4" BSP x 22



STRANGAFTAPPER (HX32)
DRAINCOCK

nr.	maat
156175	15



SCHROEFSTUK
BUITENDRAAD X INSTEK
(HX29)
BRASS ADAPTER MALE

nr.	maat
156162	1/2" x 15
156163	3/4" x 22



SCHROEFBUS
BINNENDRAAD X INSTEK
(HX28)
BRASS ADAPTER FEMALE

nr.	maat
156168	1/2" x 15
156168B	3/4" x 15
156169	3/4" x 22



KNIE INSTEK X
BUITENDRAAD
ELBOW > MALE THREAD
WINKEL AUBENGWINDE

nr.	maat
156265	15 x 1/2"
156266	22 x 3/4"



KNIE INSTEK X
BINNENDRAAD
ELBOUW > FEMALE THREAD
WINKEL INNENGEWINDE

nr.	maat
156260	15 x 1/2"
156261	22 x 3/4"



STEUNBUS (HX60)
SMARTSLEEVE PIPE
SUPPORT

nr.	verp.eenheid	maat
156210	50	15
156211	50	22



PIJPBEUGEL MET
GAT 5 MM (HX85)
PIPECLIPS SCREWTYPE

nr.	verp.eenheid	maat
156215	50	15
156216	50	22



MS T-STUK 2 X INSTEK X
BINNENDRAAD
BRASS TEE

nr.	maat
156385	15 x 1/2" x 15



PIJPENSNIJDER
PIPECUTTER SCISSOR

nr.	maat
156225	Ø10 - Ø 28



**RECHTE OVERGANGS-
KOPPELING INSTEEL X
WARTEL. (HX25)**

nr.	maat
156150	15 x 1/2"
156151	15 x 3/4"



**TANKDOORVOER INSTEEL
X BUITENDRAAD (HX20)
TANK CONNECTOR**

nr.	maat
156140	15 x 1/2"



**MUURPLAATKOPPELING
(HX6)
WALLPLATE ELBOW**

nr.	maat
156113	15 x 1/2"



**BITITE EINDKAP (HX44)
ENDCAP**

nr.	maat
156004	15
156008	22



**KLEMSTUK VOOR
KOUDBUIGEN. (HX75)
COLDFORMING
BENDFIXTURE**

nr.	maat
156230	15
156231	22



**BITITE™ DEMONTAGE
WIG (HX79)
HEPKEY**

nr.	maat
156014	15
156018	22

**EXPANSIETANK
EXPANSIONTANK
AKKUMULATOR**



Ideale aanvulling op een waterpomp. Een drukvat houdt de leidingen onder druk. Het interne membraan vangt stoten op en laat een regelmatige waterstroom door. Verlengt de levensduur van de waterpomp. Standaard ingesteld op 0,9 bar (13,05 psi). De druk kan worden aangepast.

ideal addition to a water pump. a pressure vessel keeps the pipes under pressure. the internal membrane absorbs impacts and therefore shows a regular water flow. also extends the life of the pump. default set to 0.9 bar. the pressure can be adjusted

ideale Ergänzung zu einer Wasserpumpe. Ein Druckbehälter hält die Rohre unter Druck. Die innere Membran absorbiert Stöße und zeigt daher einen regelmäßigen Wasserfluss. verlängert auch die Lebensdauer der Pumpe. Standardmäßig 0,9 bar eingestellt. Der Druck kann eingestellt werden

nr.	inhoud
156789	0,6 liter



**AFSLUITKRAAN 2X
INSTEEL (HX37C/ HX38C)
STOPCOCK**

Universeel voor koud en warm water.

nr.	maat
156134	15



CONNECT TO BETTER

Wavin Hep20

push-fit leidingsysteem
voor warm en koud water





LOOPVLAKSTRUCTUREN VOOR DE BETONINDUSTRIE

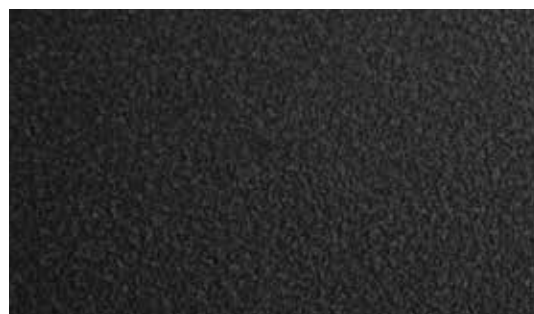

ZANDSTRAAL

De zandstraal structuur is leverbaar in verschillende maten:

Rollbreedte	: 2 meter uit voorraad leverbaar
	: 3 meter uit voorraad leverbaar
Rollengte	: 52 m ¹
Rol oppervlakte	: 104 m ² of 156 m ²

nr.	omschrijving
8844440	Zandstraal profiel met doek 2 meter
8844442	Zandstraal profiel met doek 3 meter

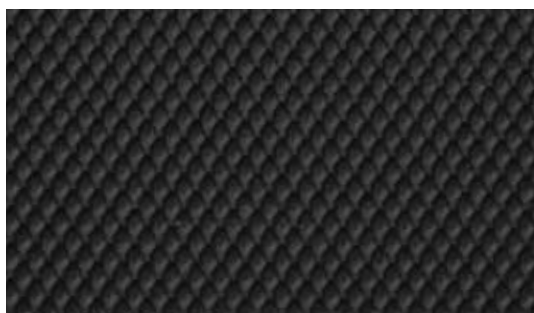

GOLF

De golf structuur is leverbaar in de volgende maten:

Rollbreedte	: 2 meter uit voorraad leverbaar
Rollengte	: 52 m ¹
Rol oppervlakte	: 104 m ²

nr.	omschrijving
8844430	Golf profiel met doek
8844432	Golf profiel met gladde onderlaag

DG STRUCTUURLIJM

DG structuurlijm is uitsluitend bestemd voor de verwerking van de diverse DG beton structuurmatten op blijvend niet afgesloten (niet ademende) ondergronden.

nr.	omschrijving
8844455	10 liter emmer, goed voor ca. 40m ² structuurmat



MANDJES

De mandjes structuur is leverbaar in de volgende maten:

Rollbreedte	: 2 meter uit voorraad leverbaar
	: 3 meter uit voorraad leverbaar
Rollengte	: 52 m ¹
Rol oppervlakte	: 104 m ² of 156 m ²

nr.	omschrijving
8844450	Mandjes profiel met doek 2 meter
8844452	Mandjes profiel met doek 3 meter



GLAD

De gladde structuur is leverbaar in de volgende maten:

Rollbreedte	: 2 meter op aanvraag leverbaar
	: 3 meter op aanvraag leverbaar.
Rollengte	: 52 m ¹
Rol oppervlakte	: 104 m ² of 156 m ²

nr.	omschrijving
8844460	Gladprofiel met doek



ZIE VOOR CELRUBBER BLADZIJDE 53

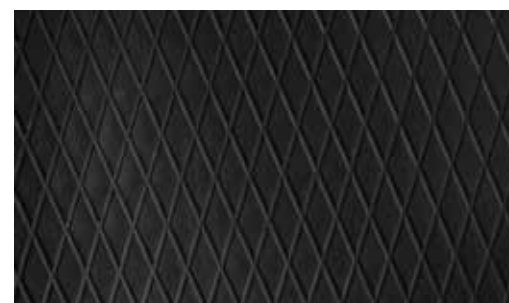

WIEBER KLEIN

De wieber structuur is leverbaar in de volgende maten:

Rollbreedte	: 2 en 3 meter uit voorraad leverbaar
Rollengte	: 52 m ¹
Rol oppervlakte	: 104 m ² of 156 m ²

nr.	omschrijving
8844420	Wieber klein met doek 2 meter breed
8844422	Wieber klein met doek 3 meter breed
8844419	Wieber klein met gladde onderlaag 3 meter breed



BLOKJES KLEIN

De blokjes structuur is leverbaar in de volgende maten:

Rollbreedte	: 2 meter uit voorraad leverbaar
	: 3 meter uit voorraad leverbaar
Rollengte	: 52 m ¹
Rol oppervlakte	: 104 m ² of 156 m ²

nr.	omschrijving
8844470	Blokjes profiel 2 meter breed, 12 x 12
8844471	Blokjes profiel 3 meter breed, 12 x 12



SCAN DE QR-CODE OM DE LOOPVLAKSTRUCTUURMATTEN METEEN TE GEBRUIKEN IN HET BESTEK

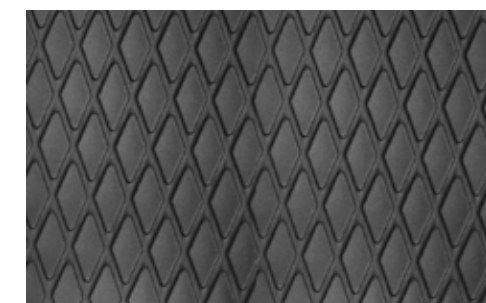

WIEBER GROOT

De wieber structuur is leverbaar in de volgende maten:

Rollbreedte	: 2 en 3 meter uit voorraad leverbaar
Rollengte	: 52 m ¹
Rol oppervlakte	: 104 m ² of 156 m ²

nr.	omschrijving
8844477	Wieber groot met doek 2 meter breed
8844478	Wieber groot met doek 3 meter breed
8844479	Wieber groot met gladde onderlaag 3 meter breed

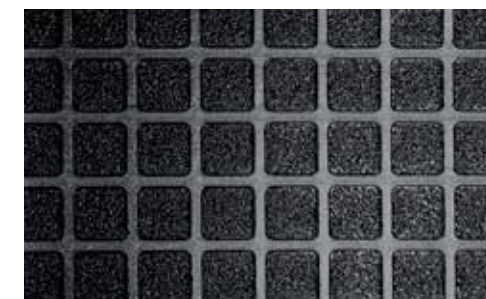

BLOKJES GROOT

De blokjes structuur is leverbaar in de volgende maten:

Rollbreedte	: 2 meter uit voorraad leverbaar
	: 3 meter uit voorraad leverbaar
Rollengte	: 52 m ¹
Rol oppervlakte	: 104 m ² of 156 m ²

nr.	omschrijving
8844487	Blokjes profiel 2 meter breed, 14,5 x 14,5
8844488	Blokjes profiel 3 meter breed, 14,5 x 14,5



**ALGEMENE VOORWAARDEN
TERMS AND CONDITIONS**

BIJZONDERE LEVERINGS-EN BETALINGSVOORWAARDEN

Alle prijzen zijn exclusief BTW, inclusief normale verpakking en gelden voor levering franco Nederlandse bestemming. Echter voor zendingen met een waarde minder dan € 495,00 (exclusief BTW), zal een bijdrage in de vrachtkosten in rekening worden gebracht. Dit is afhankelijk van het gewicht van de goederen en/of aantal colli.

Betaling

Binnen 30 dagen na factuurdatum strikt netto.

Bij opgehaalde goederen met een waarde van onder de €100,00 dient men contant te betalen.

Automatische incasso

Wij hebben de mogelijkheid tot automatisch incasso.

Export

De vrachtkosten van goederen buiten Nederland zijn altijd voor rekening van de klant.

Bank

Rabobank Nijkerk
 IBAN: NL74RABO0377813044
 BIC code/Swift adres: RABONL2U
 BTW Nummer: NL813602774B01
 K.v.K nr.: 08057144

Levering geschiedde volgens onze algemene leverings- en betalingsvoorwaarde, die vermeld staan op de laatste twee bladzijde van deze documentatie en gedeponereerd zijn bij de KVK te Eemland onder nr. 08057144.

ALGEMENE VOORWAARDEN DG RUBBER HOLLAND BV., GEVESTIGD TE NIJKERK

Artikel 1 Definities

Verkoper: DG Rubber Holland BV., de gebruiker van de algemene voorwaarden
 Koper: de wederpartij van verkoper, de afnemer; de opdrachtgever
 Overeenkomst: de overeenkomst tussen verkoper en koper.

Artikel 2 Algemeen

- De bepalingen van deze algemene voorwaarden gelden voor iedere aanbieding en overeenkomst tussen verkoper en koper waarop verkoper deze voorwaarden van toepassing heeft verklaard, voor zover van deze voorwaarden niet door partijen uitdrukkelijk en schriftelijk is afgeweken;
- De onderhavige algemene voorwaarden zijn eveneens van toepassing op alle overeenkomsten met verkoper, voor de uitvoering waarvan door verkoper van de diensten van derden gebruik wordt gemaakt;
- De toepasselijkheid van algemene voorwaarden van koper wordt uitdrukkelijk uitgesloten, tenzij partijen schriftelijk anders zijn overeengekomen. Indien de algemene voorwaarden van partijen naast elkaar van toepassing zijn geldt, dat in geval dat bepalingen in de algemene voorwaarden van verkoper en koper strijdig zijn de bepalingen in de algemene voorwaarden van verkoper prevaleren;
- Indien een of meerdere bepalingen in deze algemene voorwaarden nietig zijn of vernietigd mochten worden, blijven de overige bepalingen van deze algemene voorwaarden van toepassing. Verkoper en koper zullen nieuwe bepalingen ter vervanging van de nietige of vernietigde bepalingen overeenkomen, waarbij het doel en de strekking van de oorspronkelijke bepalingen in acht worden genomen.

Artikel 3 Aanbiedingen/Offertes/Prijzen

- Alle aanbiedingen, in welke vorm ook, zijn vrijblijvend, tenzij in het aanbod een termijn voor aanvaarding is genoemd;
- De door verkoper gemaakte offertes zijn vrijblijvend, tenzij anders aangegeven. Verkoper is slechts aan de offertes gebonden, indien de aanvaarding hiervan door koper schriftelijk binnen 14 dagen wordt bevestigd en op voorwaarde dat de in de offerte aangeboden materialen nog aanwezig zijn

- c.q. leverbaar zijn;
- Indien een natuurlijk persoon namens of voor rekening van een andere natuurlijk persoon een overeenkomst sluit, verklaart hij - door ondertekening van het contract - daartoe bevoegd te zijn. Deze persoon is naast de andere natuurlijke persoon hoofdelijk aansprakelijk voor alle uit de overeenkomst voortvloeiende verplichtingen;
- Indien de aanvaarding afwijkt van het in de offerte opgenomen aanbod, is verkoper daaraan niet gebonden. De overeenkomst komt dan niet overeenkomstig deze afwijkende aanvaarding tot stand, tenzij verkoper anders aangeeft;
- Een samengestelde prijsopgave verplicht verkoper niet tot levering van een deel van de in de aanbieding of offerte begrepen zaken tegen een overeenkomstig deel van de opgegeven prijs;
- Aanbiedingen of offertes gelden niet voor nabestellingen;
- Levertijden in offertes van verkoper zijn indicatief en geven koper bij overschrijding geen recht op ontbinding of schadevergoeding, ten zij uitdrukkelijk anders is overeengekomen;
- Overeenkomsten waarbij verkoper partij is, gelden eerst als gesloten nadat verkoper schriftelijk een order van koper heeft aanvaard c.q. de feitelijke levering af magazijn van de verkochte goederen door verkoper aan koper;
- De prijzen in de aanbiedingen/ offertes gelden voor levering af magazijn, in Euro, inclusief inladingskosten, exclusief BTW, heffingen van overheidswege, verzend-, vracht- en administratiekosten, tenzij uitdrukkelijk anders is overeengekomen;
- Verkoper mag prijsstijgingen van meer dan 10% doorberekenen, indien zich het moment van aanbidding/ aanvaarding en levering prijswijzigingen hebben voorgedaan ten aanzien van bijvoorbeeld wisselkoersen, lonen, grondstoffen, halffabrikaten of verpakkingsmateriaal;
- Indien verkoper met koper meer dan eenmaal overeenkomsten sluit, gelden terzake alle volgende overeenkomsten steeds de onderhavige algemene voorwaarden, ongeacht of deze al dan niet expliciet toepasselijk zijn verklaard.

Artikel 4 Levering

- Levering geschiedt af magazijn van verkoper, tenzij partijen anders overeenkomen;
- Koper is verplicht de zaken af te nemen op het

- moment dat verkoper deze bij hem aflevert of doet afleveren, dan wel op het moment waarop deze hem volgens de overeenkomst ter beschikking worden gesteld;
- Indien koper afname weigert of nalatig is met het verstrekken van informatie of instructies die noodzakelijk zijn voor de levering, is verkoper gerechtigd de zaken op te slaan voor rekening en risico van koper;
- Indien geleverd wordt onder rembours, brengt verkoper steeds rembourskosten in rekening bij koper;
- Indien de zaken worden bezorgd is verkoper gerechtigd eventuele bezorgkosten in rekening te brengen. Franco leveringen voor orders vanaf € 450,00 ex.BTW. Bij export zijn de transportkosten voor rekening van de koper;
- Het gewicht van de goederen bepaalt de hoogte van de vrachtkosten en deze worden apart in rekening gebracht;
- Indien verkoper een termijn voor levering heeft opgegeven, is deze indicatief. Een opgegeven levertijd is dan ook nimmer een fatale termijn. Bij overschrijding van een termijn dient koper verkoper schriftelijk in gebreke te stellen;
- Indien verkoper gegevens behoeft van koper in het kader van uitvoering van de overeenkomst, vangt de levertijd aan nadat koper deze aan verkoper ter beschikking heeft gesteld;
- Verkoper is gerechtigd de zaken in gedeelten te leveren. Verkoper is gerechtigd deellieferingen afzonderlijk te factureren.

Artikel 5 Onderzoek, reclames

- Koper is gehouden het geleverde op het moment van (af)levering, doch in ieder geval binnen zo kort mogelijke termijn, te (doen) onderzoeken. Daarbij behoort koper te onderzoeken of kwaliteit en kwantiteit van het geleverde overeenstemmen met hetgeen is overeengekomen;
- Is aan koper een model getoond, dan wordt het vermoed slechts als aanduiding te zijn getoond zonder dat de zaak daaraan behoefde te beantwoorden, tenzij uitdrukkelijk wordt overeengekomen dat de zaak daarmee zal overeenstemmen;
- Eventuele zichtbare tekorten behoren binnen 8 werkdagen na levering schriftelijk aan verkoper te worden gemeld;
- Koper dient verkoper in de gelegenheid te stellen de klacht te onderzoeken;

- Indien ingevolge het vorige lid tijdig wordt gereclameerd, blijft koper verplicht tot afname en betaling van de gekochte zaken. Wenst koper gebrekkige zaken te retourneren, dan geschiedt zulks met voorafgaande schriftelijke toestemming van verkoper op de wijze zoals door verkoper aangegeven.

Artikel 6 Betaling

- Betaling bij orders onder de € 100,00 dient te geschieden contant bij levering, overige betalingen binnen 30 dagen na factuurdatum op een door verkoper aan te geven wijze in euro's. Betaling van orders boven de € 5000,00 dient als volgt plaats te vinden:
 - 1/3 bij opdracht;
 - 1/3 wanneer de goederen ter verzending bij verkoper gereed liggen;
 - 1/3 binnen 1 maand nadat de 2e termijnbetaling is verricht;
- Bezwaren tegen de hoogte van de facturen schorten de betalingsverplichting niet op;
- Indien koper in gebreke blijft in de betaling binnen de termijn van 30 dagen, is koper van rechtswege in verzuim. Koper is alsdan een rente verschuldigd van 1% per maand of gedeelte daarvan, tenzij de wettelijke rente c.q. de wettelijke handelsrente hoger is, in welk geval de hoogste rente geldt. De rente over het opeisbare bedrag zal worden berekend vanaf het moment dat koper in verzuim is tot het moment van voldoening van het volledige bedrag;
- In geval van liquidatie, (aanvraag van) faillissement, toelating van koper tot de wettelijke schuldsanering uit hoofde van de Wet Schuldsanering Natuurlijke Personen, beslag of (voorlopige) surséance van betaling van koper zijn de vorderingen van verkoper op koper onmiddellijk opeisbaar;
- Betalingen strekken in de eerste plaats in mindering van de kosten, vervolgens in mindering van de opengevallen rente en tenslotte in mindering van de hoofdsom en de lopende rente.
- Het recht van koper om zijn vorderingen op verkoper te verrekenen is uitgesloten.

Artikel 7 Incassokosten

- Indien koper in gebreke of in verzuim is in de (tijdige) nakoming van zijn verplichtingen, komen alle redelijke kosten ter verkrijging van voldoening buiten rechte voor rekening van koper. De incassokosten worden berekend overeenkomstig het incassotarief zoals door de Nederlandse Orde van Advocaten in incasso-zaken wordt geadviseerd;
- Indien gebruiker hogere kosten heeft gemaakt, welke redelijkerwijs noodzakelijk waren, komen ook deze voor vergoeding in aanmerking;
- De eventuele gemaakte redelijke gerechtelijke en executiekosten komen eveneens voor rekening van koper.

Artikel 8 Eigendomsvoorbehoud

- Alle door de koper geleverde zaken blijven eigendom van verkoper totdat koper alle verplichtingen uit alle met verkoper gesloten overeenkomsten is nagekomen;
- Koper is niet bevoegd de onder het eigendomsvoorbehoud vallende zaken te verpanden noch op enige andere wijze te bezwaren;
- Indien derden beslag leggen op de onder eigendomsvoorbehoud geleverde zaken dan wel rechten daarop willen vestigen of doen gelden, is koper verplicht verkoper zo snel mogelijk daarvan op de hoogte te stellen;
- Door verkoper geleverde zaken, die krachtens het eerste lid van dit artikel onder het eigendomsvoorbehoud vallen, mogen slechts in het kader van een normale bedrijfsuitoefening worden doorverkocht en nimmer als betaalmiddel worden gebruikt;
- Voor het geval dat verkoper zijn in dit artikel aangeduide eigendomsrechten wil uitoefenen, geeft koper reeds nu onvoorwaardelijke en niet herroepbare toestemming aan verkoper

of door deze aan te wijzen derden om al die plaatsen te betreden waar de eigendommen van verkoper zich bevinden en die zaken mede terug te nemen.

Artikel 9 Garantie

- De door verkoper geleverde zaken voldoen aan de technische eisen en specificaties welke door de Nederlandse wetgeving worden gesteld;
- De in het eerste lid van dit artikel genoemde garantie geldt gedurende een periode van 6 maanden na levering;
- Deze garantie is beperkt tot:
 - fabrieksfouten en omvat dus geen schade ten gevolge van slijtage en oneigenlijk c.q. ondeskundig gebruik;
 - leveringen aan kopers in Nederland;
- Deze garantie vervalt:
 - bij doorverkoop van de geleverde zaken, tenzij partijen uitdrukkelijk anders zijn overeengekomen;
 - bij oordeelkundig of oneigenlijk gebruik door koper of een derde of na wijzigingen, veranderingen of reparatie door koper of een derde aan of van het geleverde;
- Zolang koper niet aan zijn verplichtingen voortvloeiende uit de door partijen gesloten overeenkomsten heeft voldaan, kan hij geen beroep doen op garantie.

Artikel 10 Opschorting en ontbinding

- Verkoper is bevoegd de nakoming van zijn verplichtingen op te schorten of de overeenkomst te ontbinden, indien:
 - * koper zijn verplichtingen uit de overeenkomst niet, niet tijdig of niet volledig nakomt;
 - * na het sluiten van de overeenkomst verkoper ter kennis gekomen omstandigheden goede grond geven te vrezen dat koper de verplichtingen niet, niet tijdig of niet volledig zal nakomen. In geval er goede grond bestaat te vrezen dat koper slechts gedeeltelijk of niet behoorlijk zal nakomen, is de opschorting slechts toegelaten voor zover de tekortkoming dit rechtvaardigt;
 - * koper bij het sluiten van de overeenkomst verzocht is zekerheid te stellen voor de voldoening van zijn verplichtingen uit de overeenkomst en deze zekerheid uitblijft of onvoldoende is. Zodra zekerheid is gesteld, vervalt de bevoegdheid tot opschorting, tenzij deze voldoening daardoor onredelijk is vertraagd;
- Voorts is verkoper bevoegd de overeenkomst te (doen) ontbinden, indien zich omstandigheden voordoen welke van dien aard zijn dat nakoming van de overeenkomst onmogelijk of naar maatstaven van redelijkheid en billijkheid niet langer kan worden gevergd dan wel indien zich anderszins omstandigheden voordoen welke van dien aard zijn dat ongewijzigde instandhouding van de overeenkomst in redelijkheid niet mag worden verwacht;
- Indien de overeenkomst wordt ontbonden, zijn de vorderingen van verkoper op koper onmiddellijk opeisbaar. Indien verkoper de nakoming van de verplichtingen opschort, behoudt hij zijn aanspraken uit de wet en overeenkomst;
- Verkoper behoudt steeds het recht schadevergoeding te vorderen.

Artikel 11 Annulering

- Indien koper, nadat een overeenkomst met verkoper tot stand is gekomen, deze wenst te annuleren, wordt 10% van de overeenkomsten orderprijs inclusief BTW als annuleringskosten bij koper in rekening gebracht, onverminderd het recht op volledige schadevergoeding, inclusief gederfde winst;
- Indien koper bij annulering de afname weigert van de reeds door verkoper aangeschafte zaken zoals materialen en grondstoffen, al dan niet be- of verwerkt, is koper gehouden alle hieruit voortvloeiende kosten aan verkoper te voldoen.

Artikel 12 Aansprakelijkheid

- Indien door verkoper geleverde zaken gebrekkig

- zijn, is de aansprakelijkheid van verkoper jegens koper beperkt tot hetgeen in deze voorwaarden onder "Garantie" is geregeld;
- Indien verkoper aansprakelijk is voor directe schade, dan is die aansprakelijkheid beperkt tot maximaal het bedrag van de door de assuradeur van verkoper te verstrekken uitkering, althans tot maximaal het factuurbedrag, althans dat gedeelte van de overeenkomst waarop de aansprakelijkheid betrekking heeft;
- Verkoper is nimmer aansprakelijk voor indirecte schade, daaronder begrepen gevolgschade, gederfde winst, gemiste besparingen en schade door bedrijfsstagnatie;
- De in deze voorwaarden opgenomen beperkingen van de aansprakelijkheid voor directe schade gelden niet indien de schade te wijten is aan opzet of grove schuld van verkoper of zijn ondergeschikten.

Artikel 13 Risico-overgang

- Het risico van verlies of beschadiging van de producten die voorwerp van de overeenkomst zijn, gaat op koper over op het moment waarop deze producten aan koper juridisch en/of feitelijk worden geleverd en daarmee in de macht van koper of van een door koper aan te wijzen derde worden gebracht;
- Indien verkoper voor transport zorgdraagt, geschiedt dit geheel op risico van koper.

Artikel 14 Overmacht

- Partijen zijn niet gehouden tot het nakomen van enige verplichting, indien zij daartoe gehinderd worden als gevolg van een omstandigheid die niet is te wijten aan grove schuld of opzet aan de zijde van de partij die zich daarop beroept, en noch krachtens de wet, een rechtshandeling of in het verkeer geldende opvattingen voor hun rekening komt;
- Onder overmacht wordt in deze algemene voorwaarden verstaan naast hetgeen daaromtrent in de wet en jurisprudentie wordt begrepen, alle van buiten komende oorzaken, voorzien of niet-voorzien, waarop verkoper geen invloed kan uitoefenen, doch waardoor verkoper niet in staat is zijn verplichtingen na te komen. Werkstakingen in het bedrijf van verkoper worden daaronder begrepen;
- Verkoper heeft ook het recht zich op overmacht te beroepen, indien de omstandigheid die (verdere) nakoming verhindert treedt nadat verkoper zijn verbintenis had moeten nakomen;
- Partijen kunnen gedurende de periode dat de overmacht voortduurt de verplichtingen uit de overeenkomst opschorten. Indien deze periode langer duurt dan twee maanden is ieder der partijen gerechtigd de overeenkomst te ontbinden, zonder verplichting tot vergoeding van schade aan de andere partij;
- Voor zoveel verkoper ten tijde van het intreden van overmacht inmiddels gedeeltelijk zijn verplichtingen uit de overeenkomst is nagekomen of deze zal kunnen nakomen, en aan het nagekomen respectievelijk na te komen gedeelte zelfstandige waarde toekomt, is verkoper gerechtigd om het reeds nagekomen respectievelijk na te komen gedeelte separaat te factureren. Koper is gehouden deze factuur te voldoen als ware het een afzonderlijk overeenkomst.

Artikel 15 speciale producten

- Tenzij uitdrukkelijk anders is overeengekomen, heeft de verkoper recht bijzondere zaken, die voor koper worden gemaakt, ook voor derden te maken.
- De koper moet monsters van bijzondere zaken keuren binnen 14 dagen na verzending. Indien verkoper na 14 dagen geen afkeurend bericht heeft ontvangen, gelden de monsters als goedgekeurd.
- Tenzij uitdrukkelijk anders is overeengekomen zijn en blijven alle modellen, matrijzen, monsters, vormen, rekeningen en alle andere apparatuur en aanwijzingen in verband met het maken van bijzondere zaken eigendom van

- verkoper.
- 15.4 Kosten van vervanging, reparaties en onderhoud van de matrijzen komen voor rekening van de koper.
- 15.5 Tekeningen, know/how en ontwerpen die de verkoper aan koper ter beschikking heeft gesteld, mogen zonder schriftelijke toestemming niet gekopieerd of aan derden ter inzage gegeven of kenbaar gemaakt worden. Zij moeten onmiddellijk na gebruik aan de verkoper worden geretourneerd. Door enkele overtreding van deze bepaling verbeurt de koper ten behoeve van verkoper een onmiddellijke opeisbare boete van € 50.000,00 per keer en van € 5.000,00 voor iedere dag dat de overtreding voortduurt.
- 15.6 De verkoper heeft het recht matrijzen te vernietigen, ongeacht of zij eigendom zijn van verkoper of van de koper, indien die 2 jaar niet zijn gebruikt. De verkoper zal de koper 3 maanden voor afloop van de 2 jaar termijn van het voornemen tot verschromting in kennis stellen.

Artikel 16 Geschillen

De rechter in de vestigingsplaats van verkoper is bij uitsluiting bevoegd van geschillen kennis te nemen. Niettemin heeft verkoper het recht het geschil voor te leggen aan de volgens de wet bevoegde rechter.

Artikel 17 Toepasselijk recht

Op elke overeenkomst tussen verkoper en koper is Nederlands recht van toepassing. Het Weens Koopverdrag is uitdrukkelijk uitgesloten.

Artikel 18 Deponering voorwaarden

Deze voorwaarden zijn zowel in Nederlands als in het Engels gedeponereerd ten kantore van Kamer Gooi-, Eem- en Flevoland onder nummer 08057144

🇬🇧 TERMS AND CONDITIONS OF DG RUBBER HOLLAND B.V., NIJKERK

Artikel 1 Interpretation

Supplier: DG Rubber Holland BV, the user of the terms and conditions;

Customer: the other Party of the Supplier, the buyer, the Client;

Agreement: the contract between Supplier and Customer;

2. General

- 2.1 These terms and conditions shall govern all social offers and agreements between supplier and customer on which Supplier declare these terms and conditions as applicable, unless both parties expressly and in writing have agreed otherwise;
- 2.2 These terms and conditions also apply to all agreements with the Customer when the supplier is making use of the third parties for the implementation of the agreement;
- 2.3 The terms and conditions the Customer are expressly not applicable, unless both parties agree otherwise in writing. If terms and conditions of both parties are applicable the provisions of the terms and conditions of the Supplier prevail in the event these are in conflict;
- 2.4 Provided that one or several of the provisions of these terms and conditions are ineffective or unrealizable, the effectiveness or unrealizable provisions by effective provisions, which correspond to the intended objective or unrealizable provisions.

3. Special offers/Offers/Prices

- 3.1 All special offers in any form are non-binding, unless a term of acceptance has been mentioned in the special offer;
- 3.2 The offers made by the Supplier are informal unless otherwise indicated. Supplier is only bound by the offer made if the Customer has accepted the offer within 14 days in writing and the materials offered are still available and/or deliverable;
- 3.3 If a natural person enters into an Agreement for another natural person he declares - by signing the Agreement - that he is fully authorized. This person is jointly liable together with the other natural person for all obligations arising from this Agreement;
- 3.4 If the acceptance is different from the contents of the offer, Supplier is not bound by it. The Agreement will not be made corresponding to this different acceptance, unless Supplier states otherwise;
- 3.5 Suppliers is not bound to deliver a part of the goods mentioned in a special offer against the given price when it is part of a combined offer;

- 3.6 Special offers or offers do not apply to re-orders;
- 3.7 The delivery dates given in any Agreement are estimates only and by any delay Customer shall not be entitled to dissolve the Agreement or to any compensation, unless expressly agreed otherwise;
- 3.8 Agreements to which Supplier is a party shall only be deemed concluded when Supplier has accepted the order in writing and/or in case of delivery the ordered goods ex warehouse by Supplier to Customer;
- 3.9 All amounts stated in the special offers/offers apply to deliver ex warehouse, are in Euros and include costs of loading, are exclusive VAT, government taxes, delivery charges, freight costs and administration costs, unless expressly agreed otherwise;
- 3.10 Supplier may pass on price increases of more than 10% if between moment of offering/accepting and delivery price changes have occurred due to e.g. foreign exchange fluctuations, wages, raw materials, semi-finished products or packaging material;
- 3.11 If Supplier and Customer enter into more than one Agreement these terms and conditions apply regardless if these expressly agreed or not.

4. Delivery

- 4.1 Delivery of the goods will be ex warehouse of Supplier, unless both parties agreed otherwise;
- 4.2 Customer has to take delivery of the goods at the moment Supplier deliver the goods or has them delivered or at the moment as agreed in the Agreement;
- 4.3 If Customer rejects the goods or is negligent in giving information or instructions regarding delivery, Supplier shall be entitled to store the goods for the account and at risk of Customer; In case of cash-on-delivery Supplier will always charge the cash-on-delivery costs to Customer;
- 4.4 In case of delivery Supplier is entitled to charge possible costs for delivery, Free delivery for orders above €450,- (four hundred and fifty euros) exclusive of VAT. In case of export Customer shall pay for the freight costs;
- 4.5 The freight costs are determined by weight and will be charged separately;
- 4.6 Any dates quoted for delivery are approximate only, and the time of delivery is not of the essence. If Supplier exceeds the time limit Customer shall send a letter off formal notice;
- 4.7 If Supplier needs information of Customer for carrying out the Agreement, delivery time will commence on receipt of this information;
- 4.8 Supplier reserves the right to effect a delivery

in parts. Supplier shall be entitled to charge for partial delivery.

5. Examinations and claims

- 5.1 Customer has to examine the goods and their packaging immediately on delivery or as quickly as possible. In addition, he has to convince himself of the Agreement-appropriate quality and quantity of the delivered good;
- 5.2 A sample shown to Customer is to be considered as indicative and will not exactly match the goods to be delivered, unless expressly agreed that it would be so;
- 5.3 Possible visible defects shall be reported in writing within 8 days after delivery to Supplier; Supplier is given a reasonable opportunity of examining the defects;
- 5.4 If under the previous paragraph complaints are made in time Customer is still required to accepting and paying the purchased goods. If Customer wants to return defective goods he shall do so with prior written permission of Supplier and will be returned in way Supplier indicates.

6. Terms of payment

- 6.1 In the case of payment for orders under €100,0 (one hundred euros) this shall be done cash-on-delivery. Other payments shall be done in euros within 30 days of the date of invoice in a way indicated by Supplier. Payment of orders above €5.000,- (five thousand euros) shall be done as follows:
- 1/3 on receipt of the order;
- 1/3 when goods are ready to be sent at Suppliers;
- 1/3 within a month of paying the second instalment payment;
- 6.2 Objections to the amount of the invoice do not suspend the payment obligation;
- 6.3 If Customer fails to make a payment within the terms of payment of 30 days, Customer is legally in default. Customer must then pay interest of 1% per month or part of that month unless the legal interest and/or commercial interest is higher, in which case the highest interest applies. The interest to be paid on the amount payable will be calculated from the date that Customer is legally in default until the date of payment of the full amount;
- 6.4 In case of liquidation, (application of) bankruptcy, admission to debt restructuring under the Natural Persons Dept Rescheduling Act, sequestration or (provisional) suspension of payments of Customer the claims of Supplier become payable on demand immediately.

- 6.5 Payments firstly reduce the costs, then the interests owed and finally the principal sum and accrued interest.
- 6.6 Customer's right to offset his claims on Supplier is excluded

7. Debt collection fees

- 7.1 If Customer defaults in (timely) payment all reasonable costs incurred in obtaining payment out of Court will be at the expense of Customer. The collection costs are calculated in accordance with the rates for collection issues as advised by the Dutch Bar Association;
- 7.2 If user had to incur costs that were reasonably necessary these are also eligible for reimbursement;
- 7.3 Possible reasonable legal expenses and execution costs are also at the expense of Customer;

8. Reservation of Title

- 8.1 All goods delivered by Supplier shall remain Suppliers property until all obligations regarding all Agreements entered into with Supplier are met by the Customer;
- 8.2 The Customer may not pledge the goods that are subject so reservation of title nor encumbered them in any other manner;
- 8.3 In the event that a third parties levy attachment on good supplied subject to the reservation of title or wish to create or assert rights on them, Customer is required to inform Supplier of this as soon as possible;
- 8.4 Items delivered by Supplier which, pursuant to section 1 of this article, are subject to reservation title, may only be resold within the scope of normal business operations and may never be used as means of payment;
- 8.5 In the event that Supplier wishes to exercise its property rights referred to this article, Customer hereby unconditionally and irrevocably authorises Supplier or third parties to be designated by Supplier to access those locations where the Supplier's goods are located and to retrieve those goods.

9. Guarantee rights

- 9.1 The goods supplied by Supplier will be in accordance with the technical requirements and specifications set by Dutch Law;
- 9.2 The Guarantee referred to in section 1 of this article shall be valid for a period of 6 months following delivery;
- 9.3 This guarantee is limited to:
- Manufacturing faults and does therefore not covered damage resulting from ware and improper and/or in expert use;
 - Delivery to buyers in the Netherlands;
- 9.4 This Guarantee will expire:
- in case of resale of the goods delivered, unless parties expressly agreed otherwise
 - in case of inappropriate or improper use by Customer or third party
 - in case of modifications, changes or repairs of the goods delivered by Customer or third party;
- 9.5 As long as the Customer fails to perform its obligations arising from the agreements concluded between the parties, it cannot invoke this warranty provision/

10. Suspension and termination

- 10.1 Supplier is authorized to suspend compliance with its obligations or dissolve the Agreement if:
- Customer fails to comply in full or good time with obligations arising from the Agreement;
 - circumstances come to the knowledge of Supplier after the Agreement is concluded which constitute a serious reason to fear that Customer will not comply in full or good time with its obligations. If there is ground to fear that the purchase will only partially be fulfilled or not properly, the suspension is only permissible to the extent that the shortcoming justifies the same;
 - Customer upon entering into the Agreement was requested to provide security for

compliance with the obligations arising from the agreement and that security is provided, the competence expires to postponement unless payment is unreasonably delayed;

- 10.2 Moreover Supplier is authorized to dissolve the Agreement or cause it to be dissolved if circumstance arise such that compliance with the Agreement may no longer be demanded of it, or may not be demanded according to any measure of reasonableness and fairness, or if circumstances otherwise arise so that the unaltered continuation of the Agreement may no longer be reasonably expected of it;
- 10.3 If the Agreement is dissolved, all amounts receivable by Supplier will be immediately due and payable. If Suppliers suspends performance of its obligations, it will retain its claim ensuing from the law and the Agreement;
- 10.4 Supplier always reserves the right to claim compensation.

11. Order cancellation

- 11.1 In the event that a Customer wishes to cancel a contract once it has been entered into, cancellation charge of 10% of the order price agreed upon (including VAT) will be made, without prejudice to Suppliers right to compensation in full for loss, including loss of profits;
- 11.2 If, in the event of cancellation, Customer refuses to purchase goods, such as materials and raw materials already acquired by Supplier, irrespective of whether these goods have been treated or processed, Customer will be obligated to pay the Supplier all ensuing costs;

12. Liability

- 12.1 Should the goods delivered by Supplier be defective, Suppliers liability towards Customer is limited to what is defined under Guarantee rights of these terms of conditions;
- 12.2 Should Supplier be liable for direct damage, this liability will be limited to the amount is paid by its insurer, or at least up to the invoice amount, or to the amount corresponding with that part of the Agreement to which the liability pertains;
- 12.3 Supplier shall never be liable for indirect damage including consequential damage, loss of profit, loss of savings and damage due to stagnation of business;
- 12.4 The limits of liability for direct damage included in these terms and conditions shall not apply if the damage is due to intent or gross negligence of Supplier or his subordinates.

13. Transfer of risk

- 13.1 The risk of loss or damage to the goods that are subject of the Agreement will pass to Customer at the time the goods in question are legally and/or actually delivered to Customer and have thus come under Customer's control or that third party designated by Customer;
- 13.2 If customer arranges transport, the expense and risk incurred will be solely for Customer

14. Force Majeure

- 14.1 Neither party will be obligated to fulfil any obligation if it is prevented from doing so due to a circumstance which cannot be attributed gross negligence or an intentional act or omission on its part, and which is also not for its account pursuant to the law, a juristic act or generally prevailing opinion;
- 14.2 In these terms and conditions, force majeure shall include, in addition to its definition provided by law and case law, all external foreseeable or unforeseeable causes which the supplier cannot influence but as result of which Supplier is unable to fulfil its obligations. Strikes at Supplier's company are included;
- 14.3 Supplier is also entitled to refer to force majeure, should the circumstances arise which makes a (further) execution of its duties impossible, after Supplier should already have executed them;
- 14.4 Parties may suspend the obligations ensuring from the Agreement during the period that the

force majeure continues. If this period lasts longer than two months, then each party is entitled to terminate the Agreement without any obligation to pay damages to the other party;

14.5 To the extent that, at the time force majeure takes effect, Supplier has partially complied with its obligations under the Agreement or will be able to comply with them, and independent value is attached to that part of the obligations that has been or will be complied with, Supplier is entitled to invoice separately for the said part. Customer shall be had to pay this invoice as if it were as separate agreement;

15. Special product

- 15.1 Unless expressly agreed otherwise, Supplier is entitled to make special product made for Customer, also third parties;
- 15.2 Customer is required to inspect samples of special products within 14 days after delivery. If Supplier doesn't receive a message of disapproval within 14 days the samples shall be considered as approved;
- 15.3 Unless expressly agreed otherwise, all models, matrices, samples, moulds, drawings and all other equipment and instructions regarding the manufacturing of these special products are and shall remain property of Supplier;
- 15.4 Costs of replacements, repairs and maintenance of the matrices are at the expense of Customer;
- 15.5 Drawings, know how and designs made available by Supplier to Customer may not be copied, or made available for examinations to third parties without written consent. The shall immediately after use be returned to Supplier. If Customer infringes upon this regulation he forfeits immediately payable fine of EUR 50.000,- (fifty thousand euros) per occasion that the violation takes place and EUR 5.000,- (five thousand euros) per day that the violation continues;
- 15.6 Supplier has the right to destroy matrices, irrespective of their ownership, if they haven't be used for 2 years. Supplier will inform Customer of his intention to destroy them 3 months in advance before the end of 2 year period.

16. Disputes

In the absence of mandatory rules of law to the contrary, the court in Supplier's place of establishment has exclusive competent jurisdiction. Nevertheless Supplier will be entitled to submit any disputes to the competent court according to the law;

17. Governing law

Dutch Law shall apply to all Agreements between Supplier and Customer. The Vienna Sales Convention is expressly excluded.

18. Registration

These Terms and Conditions are registered in Dutch with the Chamber of Commerce Gooi-, Eem-, en Flevoland under number 08057144





**RUBBER
PROFILES**



2022 / 2023
**DE EXPERT IN
TPE RUBBERPROFIELEN**
RUBBER PROFIELEN VAN TOPKWALITEIT

+31 (0) 321 74 40 42
info@dgrubberprofiles.nl
www.dgrubberprofiles.nl

DG RUBBER PROFILES B.V.
Loofklapper 16a
8256 SL Biddinghuizen



**RUBBER
PROFILES**

WAAROM TPE?

TPE is een synthetisch rubber die bij kamertemperatuur elastische druk-en trekkracht kan weerstaan.

Daarnaast heeft TPE een lange levensduur en is goed bestendig tegen UV-licht, zout water en temperatuurverschillen.

TPE is in verhouding tot andere polymeren goed te bewerken en heeft daarom relatief voordelige matrijkskosten.

WAAROM DG RUBBER PROFILES?

Door onze ervaring met TPE extrusie kunnen wij bijna elke mogelijke vorm als profiel produceren en kunnen wij snel en goedkoop leveren. Wij kunnen ons rubber in alle mogelijke RAL kleuren leveren en in 4 verschillende hardheden.



+31 (0) 321 74 40 42
info@dgrubberprofiles.nl
www.dgrubberprofiles.nl

DG RUBBER PROFILES B.V.
Loofklapper 16a
8256 SL Biddinghuizen



**BEZOEKADRES**

Melkrijder 14
3861 SG Nijkerk

POSTADRES

Postbus 1031
3860 BA Nijkerk

TELEFOON

+ 31 (0)33 245 78 86

INTERNET

www.dgrubberholland.nl

E-MAIL

info@dgrubberholland.nl